

Through-penetration Firestop Systems

System No. W-L-2761

ANSI/UL1479 (ASTM E814)	CAN / ULC S115
F Rating – 3 Hr	F Rating – 3 Hr
T Rating – 3 Hr	FT Rating – 3 Hr
	FH Rating – 3 Hr
	FTH Rating – 3 Hr

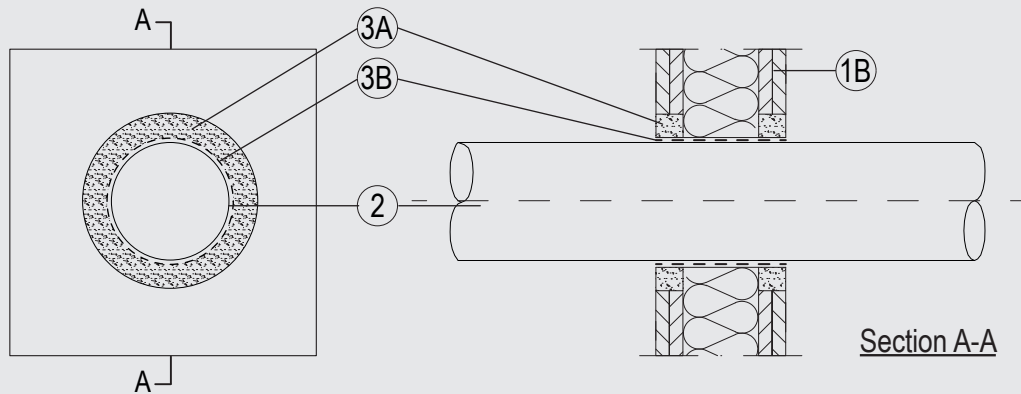

1. Wall Assembly

The 1 or 2 hr fire rated gypsum board/stud wall assembly shall be constructed of the materials and in the manner described in the individual U400, V400 or W400 Series Wall and Partition Design in the UL Fire Resistance Directory and shall include the following construction features:

- A. Studs (not shown in diagram) – Steel studs to be min 2-3/4 in. (70 mm) wide spaced max 24 in. (610 mm) OC.
- B. Gypsum Board* – The gypsum board type, thickness, number of layers, fastener type and sheet orientation shall be as specified in the individual Wall and Partition Design in the UL Fire Resistance Directory. Max size of opening to be 5.9 in. (150 mm) diameter.

2. Pipes / Tubes

Single to be installed within the opening. The annular space between the pipes and the periphery of the opening to be 1 in (25 mm). Pipes to be rigidly supported on both sides of the wall assembly. The following penetrants may be used:

- A. Nom 3.9 in (100 mm) diam 0.26 in (6.6 mm) wall thickness PP pipe for use in closed (process or supply) piping systems.

3. Firestop System

The Firestop System shall consist of the following:

- A. Packing Material – Gypsum mortar minimum 1 in. (25 mm) width and min 1 in. (25 mm) depth on both sides.
- B. Fill, Void or Cavity Material* – Overall 2 intumescent wraps. Each wrap is made up of 1 length of 2 layer of 1/16 in (1.5 mm) by 2 in. (50 mm) wrap flush mounted with the outside of the gypsum mortar / gypsum board on both sides around the pipe.

Flamro Brandschutz-Systeme GmbH – DG-CR BS