

System Flammotect 1 × 60 mm

Ablative mineral fibre board seal

Mixed penetration sealing system made of a single mineral fibre board (60 mm) with an ablative coating for electrical installations of all types as well as for combustible pipes, non-combustible pipes and further services.

Fire resistance class EI 30 – EI 60 (max. EI 90) in accordance with EN 13501-2 as per ETA-22/0052, KB 321100704-A Rev. 2.



System Flammotect 1 × 60 mm

Table of contents

Topic	Page
1. Preliminary remarks / overview	4
1.1 Target group	4
1.2 Use of the instructions	4
1.2.1 Safety instructions	4
1.3 Building elements	5
2. Allowed services	6
2.1 Cables / electrical installation conduits / wave guides / speedpipes	6
2.2 Combustible pipes	6
2.3 Multilayer pipes	7
2.4 Non-combustible pipes	7
2.5 Other services	7
3. Thicknesses, sizes and spacing	8
3.1 Initial supports	8
4. Spacing requirements for services	9
5. Included products	10
5.1 Declarations of Performance	12
6. Design	13
6.1 Fire resistance classes	13
6.2 Pipe end configurations	13
6.3 Pipe insulation configurations	13
7. Design variants	14
8. Fire protection measures	16
8.1 Cables / cable bundles / cable support systems	16
8.2 Coaxial cables and wave guides	18
8.2.1 Design with fire protection coating	18
8.2.2 Design with lamella mat	19
8.3 Electrical installation conduits	20
8.4 speedpipes	21
8.5 Combustible pipes	22
8.5.1 Design with fire protection collar	22
8.5.2 Design with fire protection wrap KSL-W	24
8.5.3 Design with FEF insulation and fire protection wrap KSL-W	27
8.6 Multilayer pipes	28
8.6.1 Design with lamella mat or FEF insulation ArmaFlex Protect	28
8.6.2 Design with FEF insulation and fire protection wrap KSL-W	30
8.6.3 Design with PEF insulation and fire protection wrap KSL-W	32
8.6.4 Design with pipe shells	33
8.7 Non-combustible pipes	34
8.7.1 Design with section insulation made of lamella mat	34

System Flammotect 1 × 60 mm

8.7.2	Design with FEF insulation and fire protection wrap NBR-plus.....	37
8.7.3	Design with FEF insulation ArmaFlex Protect.....	40
8.7.4	Design with PIR insulation	41
8.8	HVAC split line combinations	43
8.9	Double solar pipes NanoSun ²	45
9.	Installation steps.....	46

System Flammotect 1 × 60 mm

1. Preliminary remarks / overview

1.1 Target group

The installation instructions are intended solely for personnel trained in fire protection.

1.2 Use of the instructions

Before starting work, read through these installation instructions completely once. Pay particular attention to the following safety instructions.

The authorisation holder assumes no liability for damage caused by failure to comply with these instructions.

Pictorial representations serve as examples only. Installation results may differ in appearance.

Unless stated otherwise, all lengths are specified in mm.





All information in this document represents the state of the art at the time of writing or the current version of the standard.

Upon request, flamro will be pleased to provide the relevant legal and technical framework and manufacturer specifications for each individual case.



1.2.1 Safety instructions

Consult the respective safety information for the individual penetration seal components.

Personal protective equipment:

	Wear protective clothing and non-slip shoes.
	Use safety goggles, safety glasses.
	P2 particle filter in case of short-term or low level exposure. Use breathing protection in compliance with international/national standards.
	Use chemically resistant gloves. Recommended materials: butyl rubber, nitrile rubber, fluorinated rubber, PVC.

Safety instructions for the installation of floor penetration seals

	The area below the floor penetration seal must be cordoned off against entry during penetration seal work (barrier tape and warning sign: warning of possible falling objects, do not enter the area, penetration seal work in floor openings).
	The contractor for the production of floor penetration seals must inform the client in writing (for forwarding to the client or appointed representative) that after the production of the fire penetration seals in floors, these must be secured on site against loads, in particular against being stepped on, by suitable measures (e.g. by fencing or by covering with grating).

System Flammotect 1 × 60 mm

1.3 Building elements

Plasterboard walls with steel substructure

In stud design and double-sided cladding with at least 2 layers of 12.5 mm cement or gypsum-bound building boards with a reaction to fire of class A1 or A2 according to EN 13501-1.

The stud construction must be complemented by additional wall struts and transoms to form the aperture edge.

The walls must be classified with the required fire resistance rating according to EN 13501-2.

Plasterboard walls with wood substructure

In stud design and double-sided cladding with at least 2 layers of 12.5 mm cement or gypsum-bound building boards with a reaction to fire of class A1 or A2 according to EN 13501-1.

The distance between the opening and the studs and transoms must be ≥ 100 mm and the cavities between the cladding of the wall, studs and transoms and the aperture must be tightly sealed to a depth of ≥ 100 mm with mineral wool, reaction to fire class A1 or A2 according to EN 13501-1.

The walls must be classified for the required fire resistance rating in accordance with EN 13501-2.

Cladding of the aperture edge in plasterboard walls

Alongside the aperture edge, corresponding to the wall cladding, with at least one layer of 12.5 mm cement or gypsum-bound building boards with a reaction to fire of class A1 or A2 in accordance with EN 13501-1.

Solid walls

Made of concrete or reinforced concrete with a density of ≥ 2200 (± 500) kg/m³.

The walls must be classified for the required fire resistance rating in accordance with EN 13501-2.

Solid floors

Made of concrete or reinforced concrete with a density of ≥ 550 kg/m³.

The walls must be classified for the required fire resistance rating in accordance with EN 13501-2.

Timber walls and floors

Made of cross laminated timber (CLT) by the manufacturer STORA ENSO.

Wall: thickness 100 mm / layers: 30/40/30

Floor: thickness 140 mm / layers: 40/20/20/20/40

A wall or floor of cross laminated timber can be regarded as equivalent to the tested wall and floor if the following requirements are met.

- The construction of the wall/floor is identical.
- The fire resistance class of the wall/floor is identical or higher.
- The construction is certified as per EN 13501-2.
- The construction is based on the same solid wood panels as tested.
- The solid wood panels are of the same building material category as tested or of a better category.
- The strength class of the solid wood panels as per EN 338 is equivalent to the class of the tested panels or a higher class.
- The mass burning rate of the solid wood panels as per EN 1995-1-2 is equivalent to the class of the tested panels or a higher class.
- The thickness of the solid wood panel is at least equivalent to that of the tested panel.

Since particularly critical walls and floors were tested with this construction, we are also able to offer our sealing systems for timber components by other manufacturers, such as KLH, Mayr-Melnhof, Binderholz et al. Our technical service will be glad to assist you with any enquiry.

Sandwich panel walls





Sandwich panel walls PAROC AST-S/F with a thickness of ≥ 100 mm.

System Flammotect 1 × 60 mm

2. Allowed services

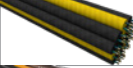
For specific fire resistance classes and pipe end configurations depending on measurements and fire protection measures see the respective chapters on design variants starting on page 14.

2.1 Cables / electrical installation conduits / wave guides / speedpipes

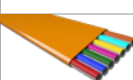
Service		max. diameter [mm]
	Cables	≤ 80
	Cable bundles	≤ 100, cable Ø ≤ 21
	Cable trays	✓
	single	≤ 32 with or without cables
	bundled	≤ 100, conduit Ø ≤ 32 with or without cables
	CommScope HELIAX®	≤ 51.1
	RFS CELLFLEX®	≤ 50.3
	RFS RADIAFLEX®	≤ 48.2
	speedpipes	≤ 40, single Ø ≤ 14

2.2 Combustible pipes



Standard pipes

Pipe material	in acc. with standard	Diameter [mm]	Pipe wall thickness
PVC-U	EN 1329-1, EN 1452-2, EN 1453-1, EN ISO 15493	32.0–160.0	1.8–11.8
PVC-C	EN 1566-1, EN ISO 15493, EN ISO 15877	32.0–160.0	1.8–11.8
PE-HD	EN 1519-1, EN 12201-2, EN ISO 15494, EN 12666-1	32.0–160.0	1.8–14.6
PP-H	EN 1451-1, EN ISO 15874, EN 15494	32.0–160.0	1.8–14.6
ABS	EN 1455-1, EN ISO 15493	32.0–160.0	1.8–14.6
SAN + PVC	EN 1565-1	32.0–160.0	1.8–14.6
PE 100	EN 1555-2, EN 12201-2+A1	32.0–110.0	1.8–10.0

System Flammotect 1 × 60 mm

Non-standard pipes	
Type of pipe	Diameter [mm]
Geberit Silent-PP	≤ 160.0
Geberit Silent-Pro	≤ 160.0
Geberit Silent-dB20	≤ 160.0
POLOPLAST POLO-KAL NG	≤ 160.0
POLOPLAST POLO-KAL XS	≤ 160.0
POLOPLAST POLO-KAL 3S	≤ 160.0
CONEL DRAIN	≤ 110.0
Wavin AS+	≤ 160.0
REHAU RAUPIANO PLUS	≤ 160.0
REHAU RAUPIANO LIGHT	≤ 110.0

2.3 Multilayer pipes



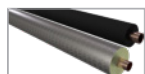

Type of pipe	Diameter [mm]
Henco Pipes	≤ 63.0
Uponor MLC Rohr white S	≤ 110.0
Geberit FlowFit	≤ 75.0
Geberit Mepla	≤ 75.0
Geberit Mepla system pipe ML	≤ 63.0

2.4 Non-combustible pipes



Pipe material	Diameter [mm]
Copper, steel, stainless steel, cast iron	≤ 88.9
Steel, stainless steel, cast iron	≤ 219.1

2.5 Other services

Service	Dimensions
 HVAC split line combinations	Copper pipe Ø 2 × 22 mm + 9 mm PE foam + 1 pipe PVC-U Ø ≤ 25.0 + 2 cables Ø ≤ 21.0 mm or 3 cables Ø ≤ 14.0 mm
 Double solar pipes NanoSun ²	DN 16–40

System Flammotect 1 × 60 mm

3. Thicknesses, sizes and spacing

Dimensions					
	Plasterboard wall, solid wall [mm]	Solid floor [mm]	Timber wall [mm]	Timber floor [mm]	Sandwich panel wall [mm]
Thickness of building element	≥ 100	≥ 150	≥ 100	≥ 140	≥ 100
Thickness of penetration seal	≥ 60	≥ 60	≥ 60	≥ 60	≥ 60
Maximum dimensions of the aperture (width × height)	2000 × 1224 / 1224 × 2000	10 000 × 1000	600 × 1000 / 1000 × 600	600 × 1000 / 420 × 3500	1000 × 1000
Distance to other penetration seals	≥ 100	≥ 100	≥ 100	≥ 100	≥ 100
Distance to other apertures or installations	≥ 200	≥ 200	≥ 200	≥ 200	≥ 200

The total allowable cross section of the installations (outer dimensions) is ≤ 60% of the construction aperture.

3.1 Initial supports

Penetrating services must be supported at the distances specified in the table below. In wall constructions support is necessary on both sides. In floor constructions support is necessary on the upper side of the floor. Essential parts of the supports must be non-combustible.

Initial supports	Wall/floor
Cables, cable bundles, cable support structures	≤ 350
Electrical installation conduits	≤ 500
Coaxial cables and wave guides	≤ 350
speedpipes for glass fibre cables and micro cables	≤ 500
Combustible pipes with fire protection collar	≤ 500
Combustible pipes with fire protection wrap	≤ 500
Multilayer pipes with section insulation made of FEF or PEF	≤ 650
Multilayer pipes with section insulation made of mineral fibre mats	≤ 850
Non-combustible pipes with section insulation made of FEF	≤ 650
Non-combustible pipes with section insulation made of PIR	≤ 650
HVAC split line combinations	≤ 250
Double solar pipes NanoSun ²	≤ 500

All specifications in mm

4. Spacing requirements for services



NOTE:

In timber components and sandwich panel walls, services must be installed at a distance of ≥ 100 mm to the aperture edge.

Spacing requirements in walls and floors

															Aperture edge		
		Single cables	Cable bundles	Cable support systems	Coaxial cables and wave guides	speedpipes	Electrical installation conduits made of plastic, single/bundled	Combustible pipes	Non-combustible pipes with FEF insulation	Non-combustible pipes with lamella mat insulation	Non-combustible pipes; insulation made of PIR	Multilayer pipes	HVAC split line combinations	Double solar pipes NanoSun²	Upper	Lower	Side
	Single cables	≥ 0	≥ 0	≥ 0	≥ 40	≥ 25	≥ 0	≥ 50	≥ 25	≥ 70	≥ 100	≥ 10	≥ 25	≥ 25	≥ 0		
	Cable bundles		≥ 0	≥ 0	≥ 40	≥ 25	≥ 0	≥ 50	≥ 25	≥ 70	≥ 100	≥ 10	≥ 25	≥ 25	≥ 0		
	Cable support systems			≥ 0 (horizontally) ≥ 50 (vertically)	≥ 40	≥ 25	≥ 0	≥ 50	≥ 25	≥ 70	≥ 100	≥ 10	≥ 25	≥ 25	≥ 0		
	Coaxial cables and wave guides				≥ 25	≥ 100	≥ 100	≥ 100	≥ 100	≥ 100	≥ 100	≥ 100	≥ 100	≥ 100	≥ 25		
	speedpipes					≥ 0	≥ 100	≥ 100	≥ 100	≥ 100	≥ 100	≥ 100	≥ 100	≥ 100	≥ 0		
	Electrical installation conduits made of plastic, single/bundled						≥ 0	≥ 100	≥ 100	≥ 100	≥ 100	≥ 100	≥ 100	≥ 100	≥ 25		
	Combustible pipes							≥ 25	≥ 50	≥ 25	≥ 100	≥ 100	≥ 100	≥ 100	≥ 25		
	Non-combustible pipes with FEF insulation								≥ 0	≥ 100	≥ 100	≥ 100	≥ 100	≥ 100	≥ 0		
	Non-combustible pipes with lamella mat insulation									≥ 0	≥ 100	≥ 100	≥ 100	≥ 100	≥ 0		
	Non-combustible pipes; insulation made of PIR										≥ 100	≥ 100	≥ 100	≥ 100	≥ 100		
	Multilayer pipes											≥ 0	≥ 100	≥ 100	≥ 0		
	HVAC split line combinations												≥ 0	≥ 100	≥ 0		
	Double solar pipes NanoSun²													≥ 0	≥ 0		

All specifications in mm. All specifications refer to distances between the respective insulations and additional measures if applicable.

System Flammotect 1 × 60 mm

5. Included products



**FLAMMOTECT-A
Coating**

5 kg pail – Art. no. 01155132
12.5 kg pail – Art. no. 01155131



**FLAMMOTECT-A
Solid emulsion**

5 kg pail – Art. no. 01155121
12.5 kg pail – Art. no. 01155136



**FLAMMOTECT-A
Filler**

5 kg pail – Art. no. 01155135
12.5 kg pail – Art. no. 01155134
310 ml cartridge – Art. no. 01155115
600 ml flow pack – Art. no. 01155153

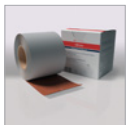

**NBR-plus
Fire protection wrap**

Roll, 5 m × 125 mm
(separable into 2 × 62.5 mm)
– Art. no. 0760150133
Roll, 10 m × 125 mm
(separable into 2 × 62.5 mm)
– Art. no. 01261941



**KSL-W
Fire protection wrap**

Roll, 10 m × 50 mm self-adhesive
– Art. no. 15510
Roll, 20 m × 50 mm self-adhesive
– Art. no. 15520
Roll, 10 m × 100 mm self-adhesive
– Art. no. 15530



Mineral wool A1

Reaction to fire class in acc. with
EN 13501-1: A1
Melting point ≥ 1000 °C
10 kg bag – Art. no. 01183000



**Mineral fibre board
in acc. with EN 13162**

Criteria: density ≥ 150 kg/m³
Reaction to fire class A1 in acc. with
EN 13501:1
Melting point ≥ 1000 °C.
(TR10) tensile strength vertical to board
surface ≥ 10 kPa according to EN 1607
Thickness ≥ 60 mm

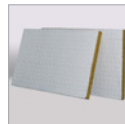

Mineral fibre boards

pre-coated on both sides with
FLAMMOTECT-A
Dimensions 1000 × 600 × 60 mm
Box with 4 pcs. – Art. no. 01182165



Label

1 piece – Art. no. 14003

System Flammotect 1 × 60 mm

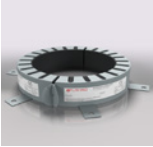
	AWM II fire protection collar Ø 32 mm – Ø 160 mm				
Dimensions [mm]	Inner Ø collar [mm]	Outer Ø collar [mm]	Overall height [mm]	Number of tabs [n]	Art. no.
32	36–40	50–54	26.0	2	01142032
40	44–48	58–62	26.0	2	01142040
50	54–57	68–71	26.0	2	01142050
63	67–70	94–97	26.0	4	01142063
75	79–83	106–110	26.0	4	01142075
90	94–100	132–138	26.6	4	01142090
110	114–120	155–161	26.6	4	01142110
125	129–135	172–178	40.0	4	01142125
140	144–152	200–206	40.0	6	01142140
160	164–169	220–225	40.0	6	01142160

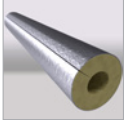
	Lamella mat or pipe shells made of mineral fibre Classification: A2-S1, d0 or A1 in acc. with EN 13501-1 Minimum bulk density: 35 kg/m ³ Melting point ≥ 1000 °C
---	---

for example:

Name	Nominal bulk density [kg/m ³]	abP/DoP
Rockwool lamella mat Klimarock Roll, 3.05 m ² – Art. no. 01187100	40–50	DE0628031801 of 14.03.2018
Rockwool ProRox PS 960 (formerly Rockwool Lapimus Rohrschale 880)	95–150	PROPS960NL-03
Rockwool 800	90–115	DE0721011801 of 15.01.2018
Rockwool ProRox WM 950 (formerly WM 80/RTD-2)	85	PROWM950D-03 of 04.05.2017
Rockwool ProRox WM WM 960 (formerly WM 100/ RBM)	100	PROWM960D-03 of 04.05.2017
Rockwool Conlit 150 U	150	P-NDS04-417
Isover Schalen Protect 1000 S, Isover Schalen Protect 1000 S Alu	70–90	DE0002-Pipe_Sections 001 of 10.06.2013
Isover mineral fibre mat MD2 and MD2/A	80	DE0002-Protect_EN14303 002 of 09.02.2015
Isover mineral fibre mat MDD and MDD/A	115	
PAROC Hvac Section AluCoat T	85–120	40361
PAROC Pro Section 100	100	40080
PAROC Hvac Lamella Mat AluCoat Fix	50	40236

System Flammotect 1 × 60 mm

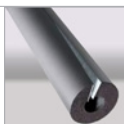

Section and protective insulations
made of flexible elastomeric foam (FEF)
in accordance with EN 14304

for example:

Name	abP/DoP
ArmaFlex Protect	(0543-CPR-2016-001 of 01.04.2015)
AF/ArmaFlex	0543-CPR-2016-001 of 01.04.2015
AF/ArmaFlex Evo	0543-CPR-2020-101
SH/ArmaFlex	0543-CPR-2013-013 of 01.01.2015
NH/ArmaFlex	0552-CPR-2013-015 of 08.08.2018
NH/ArmaFlex Smart	0543-CPR-2020-102
ArmaFlex LS	0551-CPR-2016-066
ArmaFlex Ultima	0543-CPR-2016-017
FEF Kaiflex KKplus s1	DoP KKplus s1 01032018001 of 01.03.2018
FEF Kaiflex HTplus	DoP HTplus s1 01032018001 of 01.03.2018
K-Flex R90	P-2300/871/16-MPA BS of 04.10.2016
flexen Heizungskautschuk	LE_5258006015_00_M_flexen_Heizungskautschuk of 30.06.2013
flexen Kältekautschuk	LE_0869806006_00_M_flexen_Kältekautschuk of 30.06.2013
EUROBATEX	01/20190610
EUROBATEX HF	03/20171201

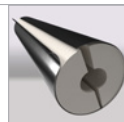

PIR pipe sleeves
made of polyisocyanurate in acc. with EN 14308

Manufacturer	swisspor AG, CH-6312 Steinhausen
Bulk density	~32 kg/m ³
Declaration of Performance	LE-013.1.0-HT-15.2
or PIR pipe sleeves with equivalent parameters	

5.1 Declarations of Performance

The Declarations of Performance for the featured products are available for download on our website:

<https://flamro.com/eu/downloads/>

System Flammotect 1 × 60 mm

6. Design

6.1 Fire resistance classes

System Flammotect 1 × 60 mm meets the requirements of max. class EI 90 in acc. with EN 13501-2.

The fire resistance class of the sealing system is reduced to the fire resistance class of the installed service with the lowest fire resistance rating.

The fire resistance class of the sealing system is reduced to the maximum fire resistance class of the surrounding building element.

Building element	Fire resistance class
Plasterboard wall	max. EI 90
Solid wall	max. EI 90
Solid floor	max. EI 90
Timber wall (CLT)	max. EI 60
Timber floor (CLT)	max. EI 60
Sandwich panel wall	max. EI 60

6.2 Pipe end configurations

Non-combustible pipes				
tested	included configurations			
	U/U	U/C	C/U	C/C
U/U	✓	✓	✓	✓
U/C	-	✓	✓	✓
C/U	-	-	✓	✓
C/C	-	-	-	✓

Combustible pipes				
tested	included configurations			
	U/U	U/C	C/U	C/C
U/U	✓	✓	✓	✓
U/C	-	✓	-	✓
C/U	-	✓	✓	✓
C/C	-	-	-	✓

6.3 Pipe insulation configurations

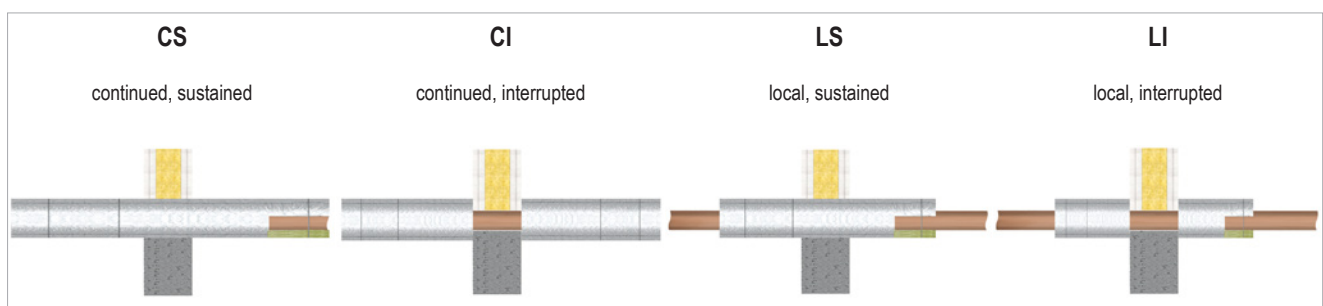

Results for LS insulation are also applicable to CS insulation.
 Results for LI insulation are also applicable to CI insulation.

System Flammotect 1 × 60 mm

7. Design variants

The sealing system may be used to close apertures without installations (reserve penetration for subsequent configurations).

Pieces of the mineral fibre boards must be coated with FLAMMOTECT-A so that they are glued together. The edges of the mineral fibre board and/or the aperture edge must be coated with FLAMMOTECT-A so that the board is glued to the building element.

Final coating of the outer board surface and a surrounding area of ≥ 20 mm with FLAMMOTECT-A (dry film thickness 0.75 mm).

Sealing of annular gap:

≤ 5 mm by filling the entire depth with FLAMMOTECT-A ,

> 5 mm by filling with loose mineral wool and coating with FLAMMOTECT-A (dry film thickness ≥ 0.75 mm).

Design variants for plasterboard walls and solid walls

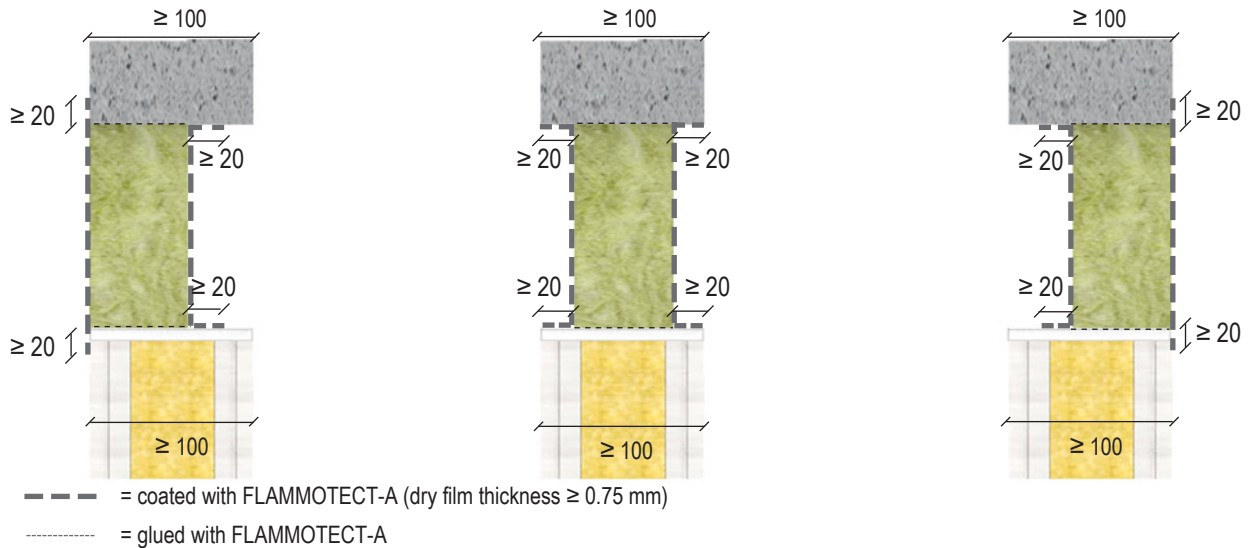

All specifications in mm

Design variants in solid floors

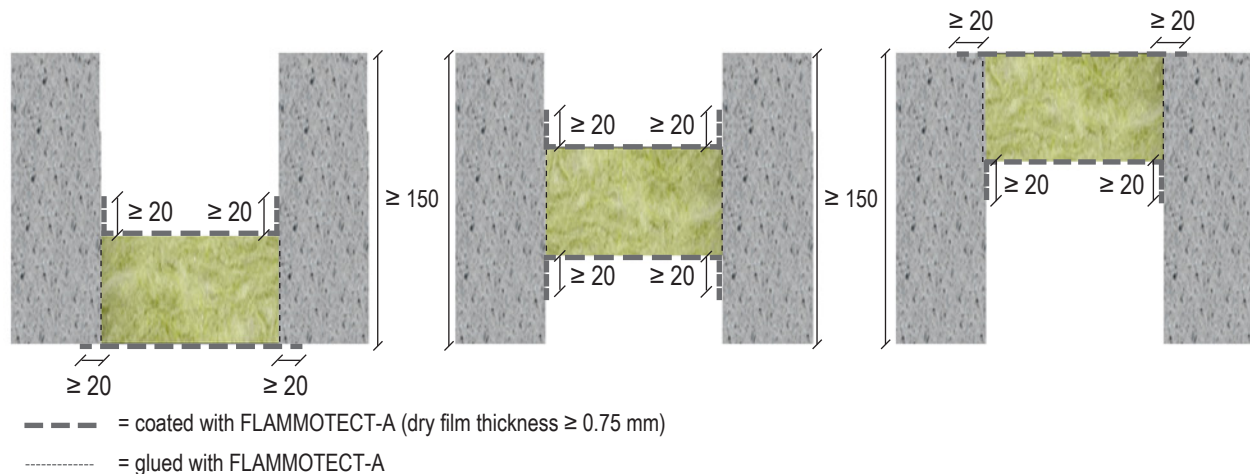

All specifications in mm

System Flammotect 1 × 60 mm

In timber walls and floors, the spacing distance between applied services and aperture edge must always be at least 100 mm (see chapter „Spacing requirements for services“ on page 9).

In timber walls and floors the penetration seal must always be positioned in the centre.

Design variants in timber walls

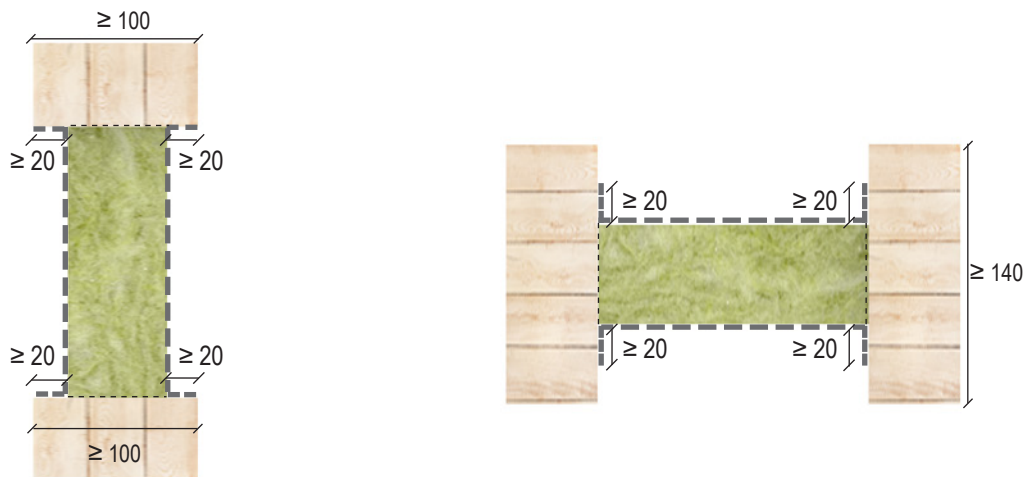

- = coated with FLAMMOTECT-A (dry film thickness ≥ 1.0 mm)
- = glued with FLAMMOTECT-A

All specifications in mm

On both sides of the seal, L profiles with the dimensions 30 × 30 × 2 mm must be attached alongside the aperture edge.

Design variants in sandwich panel walls

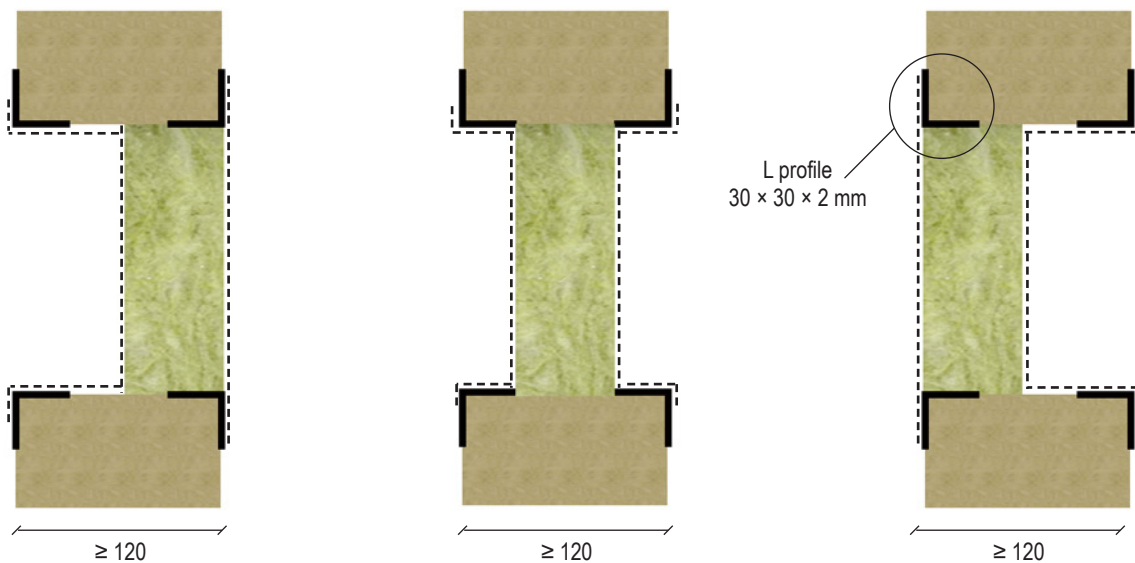

- = coated with FLAMMOTECT-A (dry film thickness ≥ 0.75 mm)

All specifications in mm

System Flammotect 1 × 60 mm

8. Fire protection measures

8.1 Cables / cable bundles / cable support systems

Cables and cable bundles may be installed with or without cable trays.

Cable bundles may be installed unopened in the seal. It is not necessary to fill the interstices of the bundles consist of parallel-running cables that are tightly packed, tied, stitched or welded together.

The supporting structures for cable trays must be designed in such a way that the penetration seal will not be subjected to additional mechanical stress in case of fire.

In the penetrated area (inside the mineral fibre boards), all cables must be coated with FLAMMOTECT-A. (For the necessary dry film thickness, see table below.)

Alternatively to coating, the fire protection wrap NBR-plus may also be applied to services.

The fire protection wrap NBR-plus is coated on one side and equipped with a protective film. The film must be removed before applying the wrap. The wrap is applied with the coated side facing inwards and fastened with steel wires.

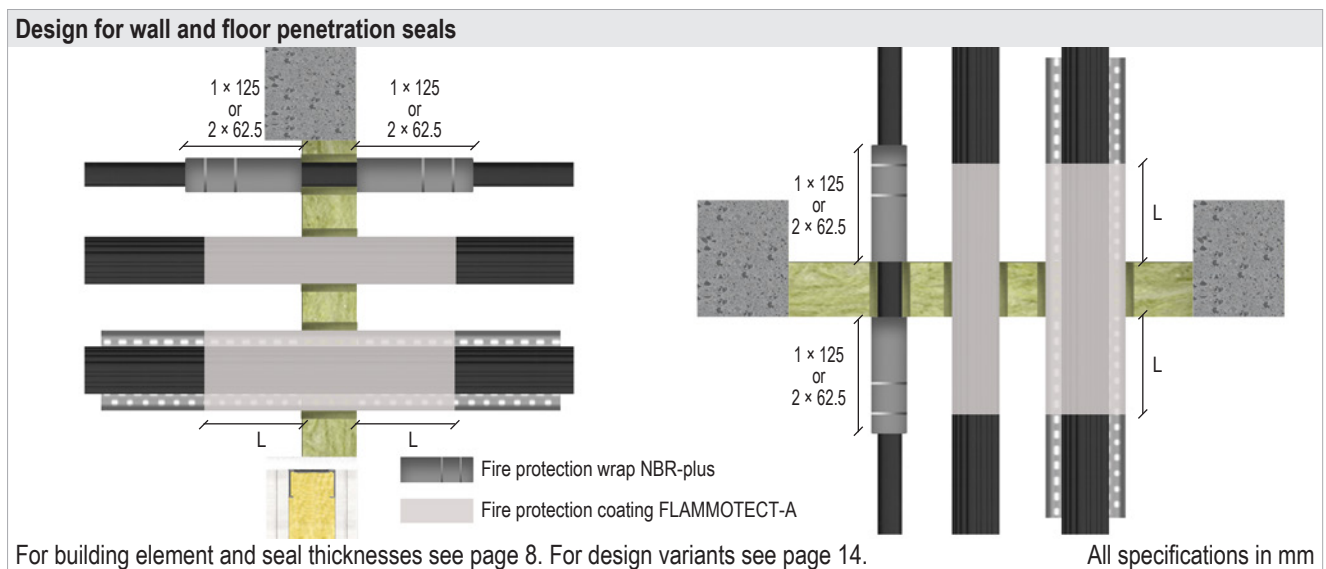

System Flammotect 1 × 60 mm

Services	Dimensions [mm]	Coating with FLAMMOTECT-A			Fire resistance class	
		Dry film thickness [mm]	Inside seal [mm]	In front of seal [mm]	Wall	Floor
Cables	Ø ≤ 21 (without cable tray through drill holes)	≥ 0.75	60	≥ 100	–	EI 90
	Ø ≤ 21	≥ 0.75		≥ 100	EI 60 / E 90	EI 60 / E 90
	Ø > 21 to ≤ 50	≥ 0.75		≥ 100		
	Ø > 50 to ≤ 80	≥ 0.75		≥ 100		
Cable bundles	Ø ≤ 100	≥ 0.75		≥ 100		
	Ø ≤ 100	≥ 1.00		≥ 150	EI 90	

Services	Dimensions [mm]	Fire protection wrap NBR-plus	Fire resistance class	
			Wall	Floor
Cables	Ø ≤ 21 (without cable tray through drill holes)	on both sides 1 × 125 mm, 1 layer with 45 mm overlap	EI 90	EI 90
	Ø ≤ 21		EI 60 / E 90	EI 60 / E 90
	Ø > 21 to ≤ 50			
	Ø > 50 to ≤ 80			
Cable bundles	Ø ≤ 100			

System Flammotect 1 × 60 mm

8.2 Coaxial cables and wave guides

8.2.1 Design with fire protection coating

All coaxial cables and wave guides must be coated on both sides of the seal with FLAMMOTECT-A at a length of ≥ 100 mm (measured from seal surface).

In the penetrated area (inside the mineral fibre boards), all coaxial cables and wave guides must be coated with FLAMMOTECT-A (dry film thickness ≥ 1.0 mm).

Design for wall and floor penetration seals



For building element and seal thicknesses see page 8. For design variants see page 14.

All specifications in mm

Service	Coating with FLAMMOTECT-A		Fire resistance class	
	Inside seal [mm]	In front of seal [mm]	Wall	Floor
CommScope HELIAX®, $\varnothing \leq 51.1$	60	≥ 100	EI 45 U/C / E 90 U/C	EI 45 U/C / E 90 U/C
RFS CELLFLEX®, $\varnothing \leq 50.3$			EI 60 U/C / E 90 U/C	EI 45 U/C / E 90 U/C
RFS RADIAFLEX®, $\varnothing \leq 48.2$			EI 60 U/C / E 90 U/C	EI 60 U/C / E 90 U/C

System Flammotect 1 × 60 mm

8.2.2 Design with lamella mat

The lamella mat must be secured with winding wire against falling out.

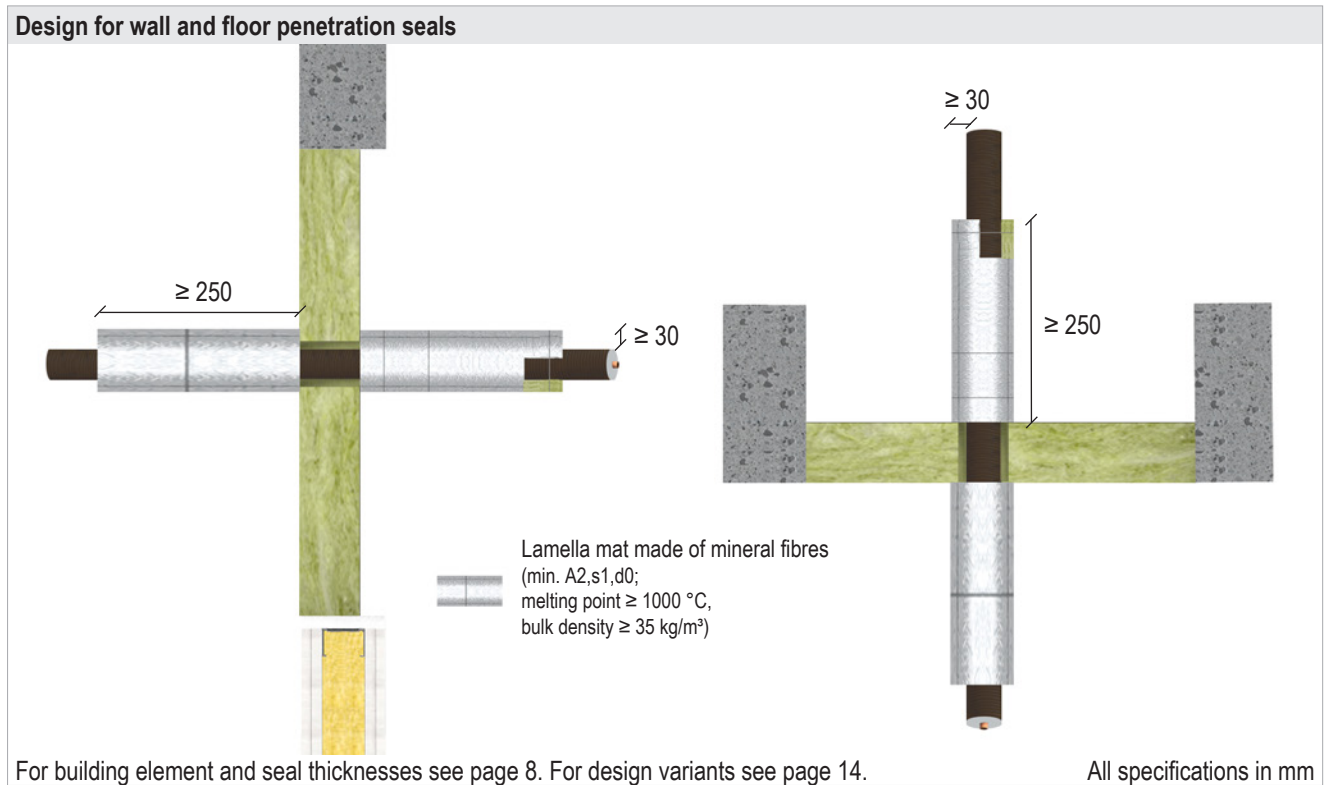

Service	Section insulation made of lamella mat		Fire resistance class	
	Length	Thickness	Wall	Floor
CommScope HELIAX®, $\varnothing \leq 51.1$	≥ 250	≥ 30	EI 60 U/C / E 90 U/C	EI 60 U/C / E 90 U/C
RFS CELLFLEX®, $\varnothing \leq 50.3$			EI 45 U/C / E 90 U/C	EI 60 U/C / E 90 U/C
RFS CELLFLEX®, $\varnothing 28.0$			EI 60 U/C / E 90 U/C	EI 60 U/C / E 90 U/C
RFS RADIAFLEX®, $\varnothing \leq 48.2$			EI 60 U/C / E 90 U/C	EI 90 U/C

System Flammotect 1 × 60 mm

8.3 Electrical installation conduits

It is possible to install both single and bundled EICs with or without cables.

Electrical installation conduits must protrude at least 150 mm from the seal.

Electrical installation conduits must be wrapped with the fire protection wrap NBR-plus.

The fire protection wrap NBR-plus is coated on one side and equipped with a protective film. The film must be removed before applying the wrap with the coated side facing inwards.

For easier installation the wrap can be secured against falling out with duct tape or winding wire.

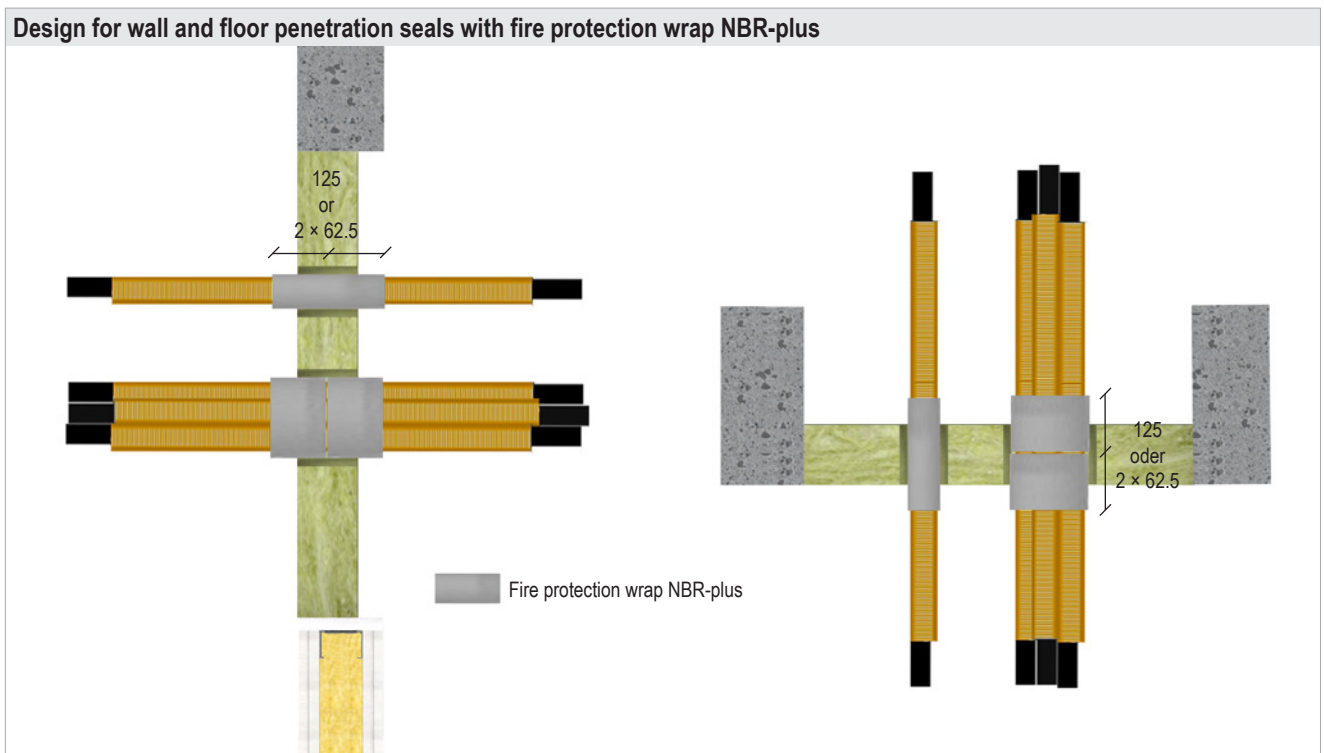

For building element and seal thicknesses see page 8. For design variants see page 14.

All specifications in mm

Service	Dimensions	Fire protection wrap NBR-plus		Fire resistance class	
		Number of wraps × width [mm]	Number of layers [n]	Wall	Floor*
Conduits made of plastic, single (with/without cables)	$\varnothing \leq 32$	1 × 125 or 2 × 62.5	2	EI 60 / E 90 U/U	EI 90 U/U
Conduits made of plastic, bundled (single conduits $\varnothing \leq 32$ with/without cables)	$\varnothing \leq 70.0$			EI 60 / E 90 U/U	EI 90 U/U
	$\varnothing \leq 80.0$			EI 60 / E 90 U/U	EI 60 U/U
	$\varnothing \leq 100.0$			EI 60 / E 90 U/U	EI 45 U/U / E 90 U/U

* as per KB 321100704-A Rev. 2

System Flammotect 1 × 60 mm

8.4 speedpipes

The fire protection wrap NBR-plus is coated on one side and equipped with a protective film. The film must be removed before applying the wrap with the coated side facing inwards.

For easier installation the wrap can be secured against falling out with duct tape or winding wire.

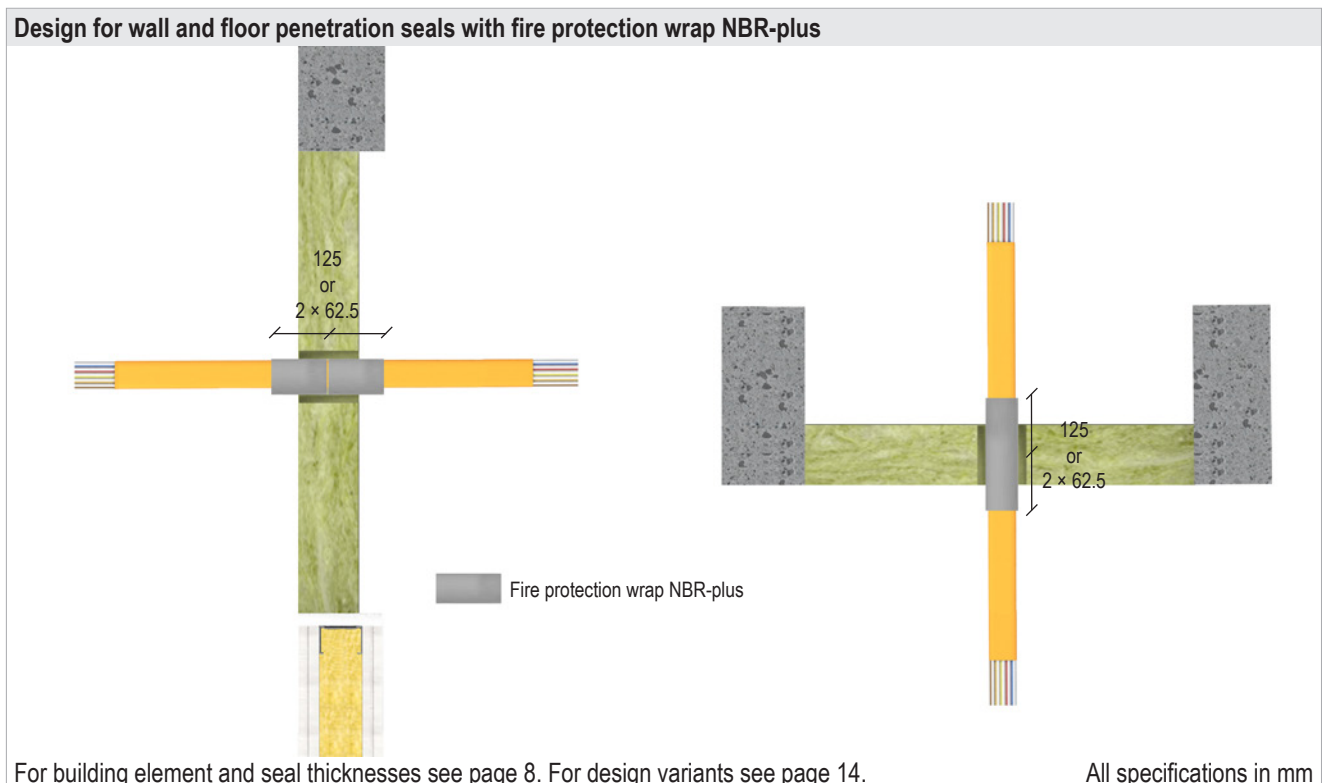

Configuration	Fire protection wrap NBR-plus		Fire resistance class	
	Number of wraps × width [mm]	Number of layers [n]	Wall	Floor
Bundle Ø ≤ 40 mm Single Ø ≤ 14 mm	1 × 125 or 2 × 62.5	1	EI 60 U/U / E 90 U/U	EI 90 U/U
Bundle Ø ≤ 40 mm Single Ø ≤ 7 mm			EI 90 U/U	EI 90 U/U

System Flammotect 1 × 60 mm

8.5 Combustible pipes

8.5.1 Design with fire protection collar

Collars must be attached on both sides in walls and on the lower side in floors. Always use the smallest collar fitting the diameter of the pipe.

Collars must be fastened to the seal with continuous threaded rods \varnothing M6–M8, washers and nuts.

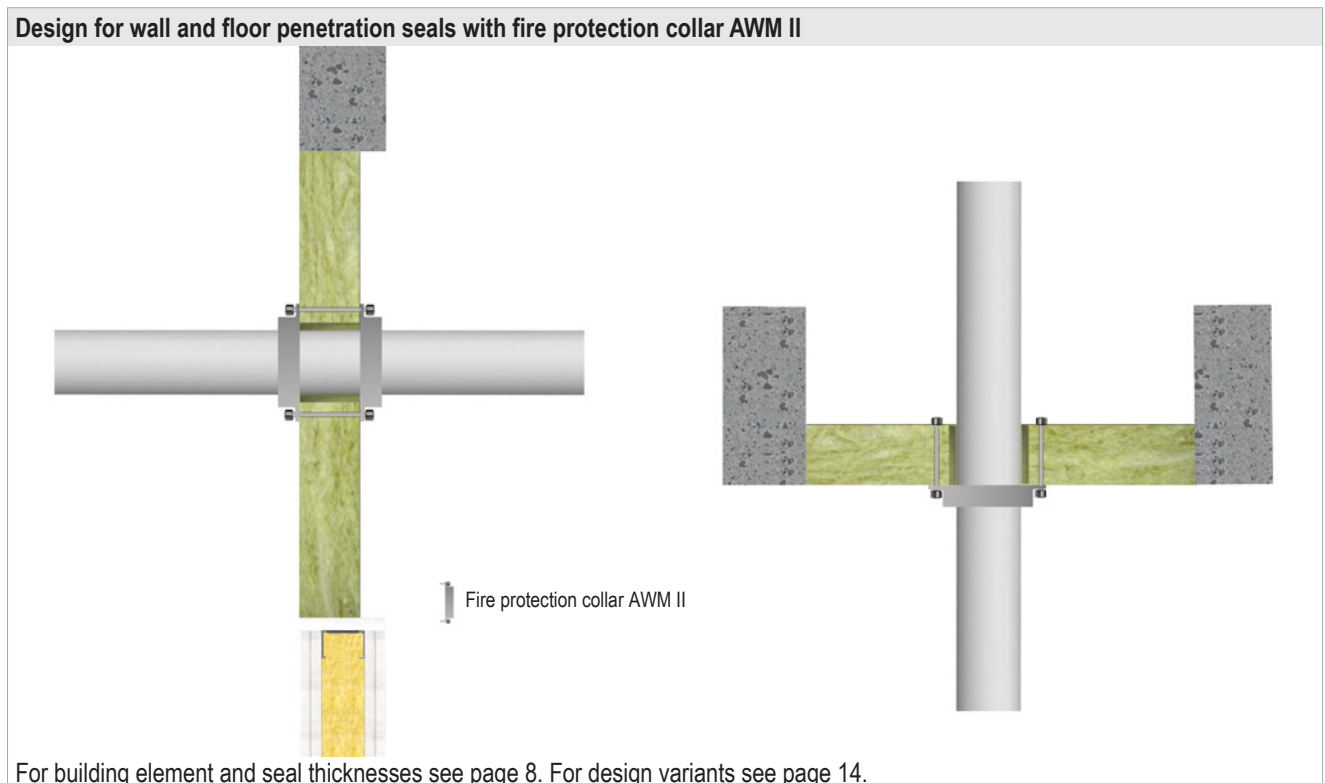

Wall					
Pipe material	Pipe diameter [mm]	Pipe thickness [mm]	Fire protection collar AWM II	Fire resistance class	
PVC-U, PVC-C	32.0–50.0	1.5–5.6	on both sides	EI 90 U/U	
	63.0–75.0	1.6–6.6			
	90.0–110.0	1.8–8.1			
	125.0–160.0	3.2–11.8			
PE-HD, ABS, SAN + PVC	32.0–50.0	1.8–4.6		EI 90 U/U	
		2.2–6.6			
	63.0–75.0	5.1–6.6			EI 60 U/U / E 90 U/U
		2.7–10.0			EI 90 U/U
	90.0–110.0	10.0			EI 60 U/U / E 90 U/U
		4.0–14.6			EI 90 U/U
PP-H	32.0–50.0	1.8–4.6		EI 90 U/U	
		2.2–6.6			
	90.0–110.0	2.7–10.0			
		4.0			
	125.0–160.0	4.0–14.6	EI 60 U/U / E 90 U/U		

System Flammotect 1 × 60 mm

Wall			
Type of pipe	Outer diameter [mm]	Fire protection collar AWM II	Fire resistance class
REHAU RAUPIANO LIGHT, CONEL DRAIN	≤ 75.0	on both sides	EI 90 U/U
	90.0		EI 60 U/U / E 90 U/U
	110.0		EI 90 U/U
Geberit Silent-db20	≤ 160.0		EI 90 U/U
Geberit Silent-PP	≤ 160.0		EI 90 U/U
Geberit Silent-Pro	≤ 160.0		EI 90 U/U
POLOPLAST POLO-KAL 3S*	≤ 160.0		EI 90 U/U*
POLOPLAST POLO-KAL NG POLOPLAST POLO-KAL XS	≤ 160.0		EI 90 U/U
REHAU RAUPIANO PLUS	50.0		EI 90 U/U
	75.0		EI 60 U/U / E 90 U/U
	≤ 160.0		EI 90 U/U
Wavin AS+	≤ 160.0		EI 90 U/U

Floor				
Pipe material	Pipe diameter [mm]	Pipe thickness [mm]	Fire protection collar AWM II	Fire resistance class
PVC-U, PVC-C	32.0–50.0	1.5–5.6	on lower side	EI 60 U/U / E 90 U/U
	63.0–75.0	1.6–6.6		EI 60 U/U / E 90 U/U
	90.0–110.0	1.8–7.0/8.1		EI 60 U/U / E 90 U/U
	125	2.5–9.2		EI 60 U/U / E 90 U/U
	140.0–160.0	3.2–11.8		EI 60 U/U / E 90 U/U
PE-HD, ABS, SAN + PVC	32.0–50.0	1.8–4.6		EI 60 U/U
	63.0–75.0	2.3–6.6		EI 90 U/U
	90.0	2.8–8.2		EI 90 U/U
	110.0	3.4–10.0		EI 90 U/U
	140.0–≤ 160.0	4.0–14.6		EI 60 U/U
PP-H	32.0–50.0	1.8–4.6		EI 60 U/U
	63.0–75.0	1.9–8.6		EI 90 U/U
	90.0	2.2–8.2		EI 90 U/U
	110.0	2.7–10.0	EI 90 U/U	
	125.0	3.1–3.9	EI 90 U/U	
	125.0–160.0	4.0–14.6	EI 60 U/U	

Floor			
Type of pipe	Outer diameter [mm]	Fire protection collar AWM II	Fire resistance class
Geberit Silent-db20	≤ 160	on lower side	EI 90 U/U
Geberit Silent-PP	≤ 160		EI 90 U/U
Geberit Silent-Pro	≤ 110		EI 90 U/U
	≤ 160		EI 60 U/U / E 90 U/U

* as per KB 321100704-A Rev. 2

System Flammotect 1 × 60 mm

8.5.2 Design with fire protection wrap KSL-W

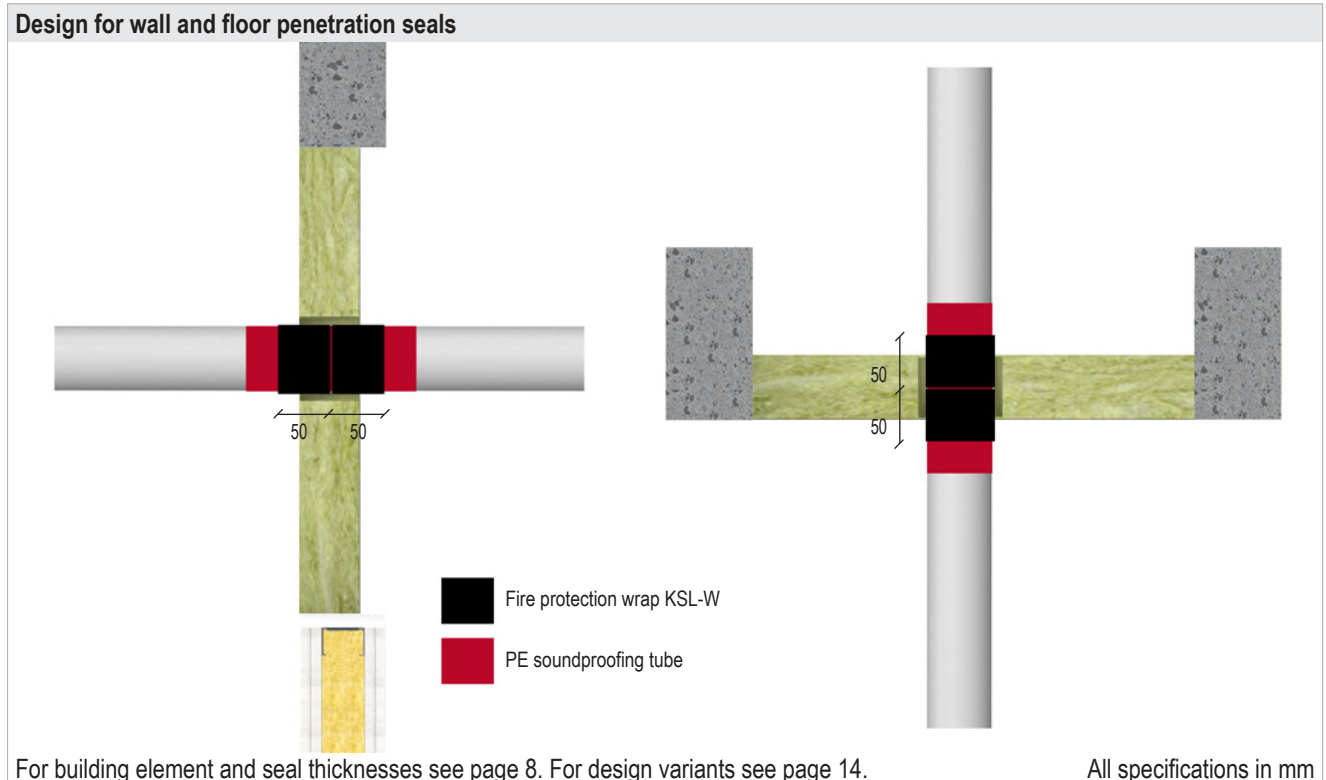

Wall					
Pipe material	Outer diameter [mm]	Wall thickness [mm]	Fire protection wrap KSL-W		Fire resistance class*
			Number of wraps × width [mm]	Number of layers [n]	
PVC-U, PVC-C	32.0–50.0	2.4–5.6	2 × 50	2	EI 60 U/U
	63.0–75.0	2.8–4.6		3	EI 60 U/U
	90.0–110.0	3.2		4	EI 60 U/U
PE-HD, ABS, SAN + PVC	32.0–50.0	1.8–4.6		2	EI 60 U/U
	63.0–75.0	2.2–5.4		3	EI 60 U/U
		> 5.4–6.9		4	EI 30 U/U
		2.7–6.6		4	EI 60 U/U
	90.0–110.0	> 6.6–10.0		4	EI 30 U/U
				4	EI 60 U/U
PP-H	32.0–50.0	2.0–6.9		2	EI 90 U/U
	63.0–75.0	2.2–8.1		3	EI 60 U/U
		2.6–5.5	3	EI 90 U/U	
	90.0	2.9–4.5	4	EI 90 U/U	
	90.0–110.0	2.7–10.0	4	EI 60 U/U	
	110.0	3.4	4	EI 90 U/U	

System Flammotect 1 × 60 mm

Wall				
Type of pipe	Outer diameter [mm]	Fire protection wrap KSL-W		Fire resistance class*
		Number of wraps × width [mm]	Number of layers [n]	
REHAU RAUPIANO LIGHT, CONEL DRAIN	50	2 × 50	2	EI 90 U/U
	≤ 110.0		4	EI 90 U/U
Geberit Silent-db20	56		2	EI 90 U/U
	≤ 110.0		4	
Geberit Silent-PP	50		2	EI 60 U/U / E 90 U/U
	≤ 110.0		4	
Geberit Silent-Pro	50		2	EI 60 U/U / E 90 U/U
	≤ 110.0		4	
POLOPLAST POLO-KAL 3S	75.0		3	EI 60 U/U / E 90 U/U
	≤ 110.0		4	
POLOPLAST POLO-KAL NG POLOPLAST POLO-KAL XS	50		2	EI 90 U/U
	≤ 110.0		4	
REHAU RAUPIANO PLUS	50.0		2	EI 90 U/U
	≤ 110.0		4	EI 90 U/U
Wavin AS+	50		2	EI 90 U/U
	≤ 110.0		4	

Floor					
Pipe material	Outer diameter [mm]	Wall thickness [mm]	Fire protection wrap KSL-W		Fire resistance class*
			Number of wraps × width [mm]	Number of layers [n]	
PVC-U, PVC-C	32.0–50.0	2.4	2 × 50	2	EI 60 U/U
		2.4–3.7			EI 30 U/U
	63.0	3.7–5.5		3	EI 30 U/U
	75.0	4.8–5.5		3	EI 30 U/U
	90.0	6.0–6.5		4	EI 30 U/U
	110.0	8.1		4	EI 30 U/U
PE-HD, ABS, SAN + PVC	32.0–50.0	1.8–4.6	2	EI 90 U/U	
	63.0–75.0	2.2–6.9	3	EI 90 U/U	
	90.0–110.0	2.7–10.0	4	EI 90 U/U	
PP-H	32.0	6.9	2	EI 90 U/U	
	32.0–50.0	2.0–6.9	2	EI 60 U/U / E 90 U/U	
		2.3–8.1	3	EI 60 U/U / E 90 U/U	
	63.0–75.0	5.1–6.7	3	EI 90 U/U	
		2.7–6.3	4	EI 90 U/U	
	90.0–110.0	2.7–10.0	4	EI 60 U/U / E 90 U/U	

System Flammotect 1 × 60 mm

Floor				
Type of pipe	Outer diameter [mm]	Fire protection wrap KSL-W		Fire resistance class*
		Number of wraps × width [mm]	Number of layers [n]	
REHAU RAUPIANO LIGHT, CONEL DRAIN	50	2 × 50	2	EI 60 U/U / E 90 U/U
Geberit Silent-db20	56		2	EI 90 U/U
	≤ 110		4	EI 90 U/U
Geberit Silent-PP	50		2	EI 60 U/U / E 90 U/U
	≤ 110		4	EI 60 U/U / E 90 U/U
Geberit Silent-Pro	50		2	EI 90 U/U
	≤ 110		4	EI 90 U/U
POLOPLAST POLO-KAL 3S	75		3	EI 60 U/U / E 90 U/U
	≤ 110		4	EI 60 U/U / E 90 U/U
POLOPLAST POLO-KAL NG	50		2	EI 60 U/U
POLOPLAST POLO-KAL XS	≤ 110		4	EI 60 U/U
REHAU RAUPIANO PLUS	50		2	EI 60 U/U / E 90 U/U
Wavin AS+	50		2	EI 90 U/U
	≤ 110		4	EI 90 U/U

* as per KB 321100704-A Rev. 2

System Flammotect 1 × 60 mm

8.5.3 Design with FEF insulation and fire protection wrap KSL-W

Design for wall penetration seals

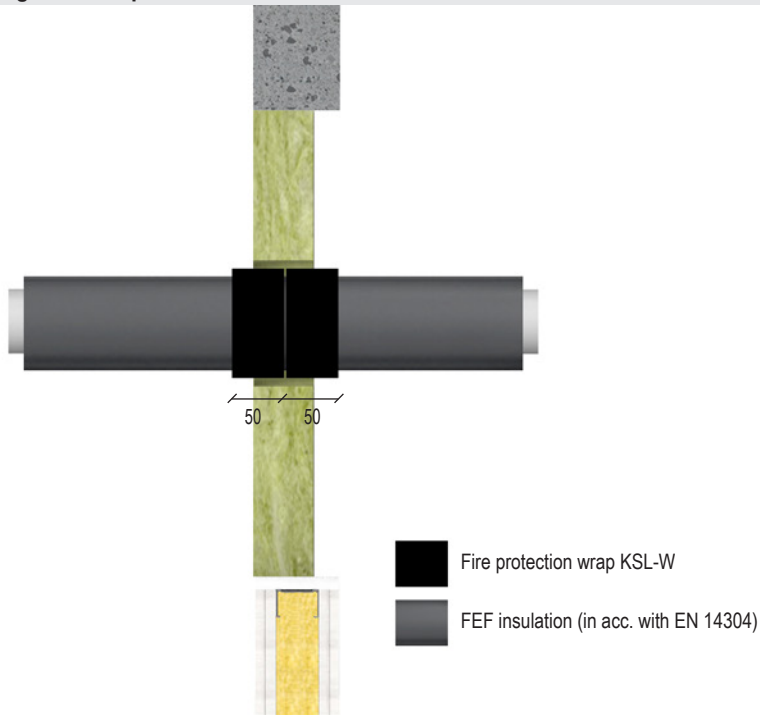

For building element and seal thicknesses see page 8. For design variants see page 14.

All specifications in mm

Combustible pipes made of PVC-U, PVC-C, PP-H

Dimensions		FEF insulation Length	Fire protection wrap KSL-W		Fire resistance class
Pipe outer Ø [mm]	Pipe wall thickness [mm]		Number of wraps × width [mm]	Number of layers [n]	Wall
40–50	1.5–4.6	9.0–20.5	2 × 50	2	EI 60 U/U / E 90 U/U
				3	EI 90 U/U
50–75	1.9–8.2	9.0–22.0		2	EI 60 U/U / E 90 U/U
				3	EI 90 U/U

System Flammotect 1 × 60 mm

8.6 Multilayer pipes

8.6.1 Design with lamella mat or FEF insulation ArmaFlex Protect

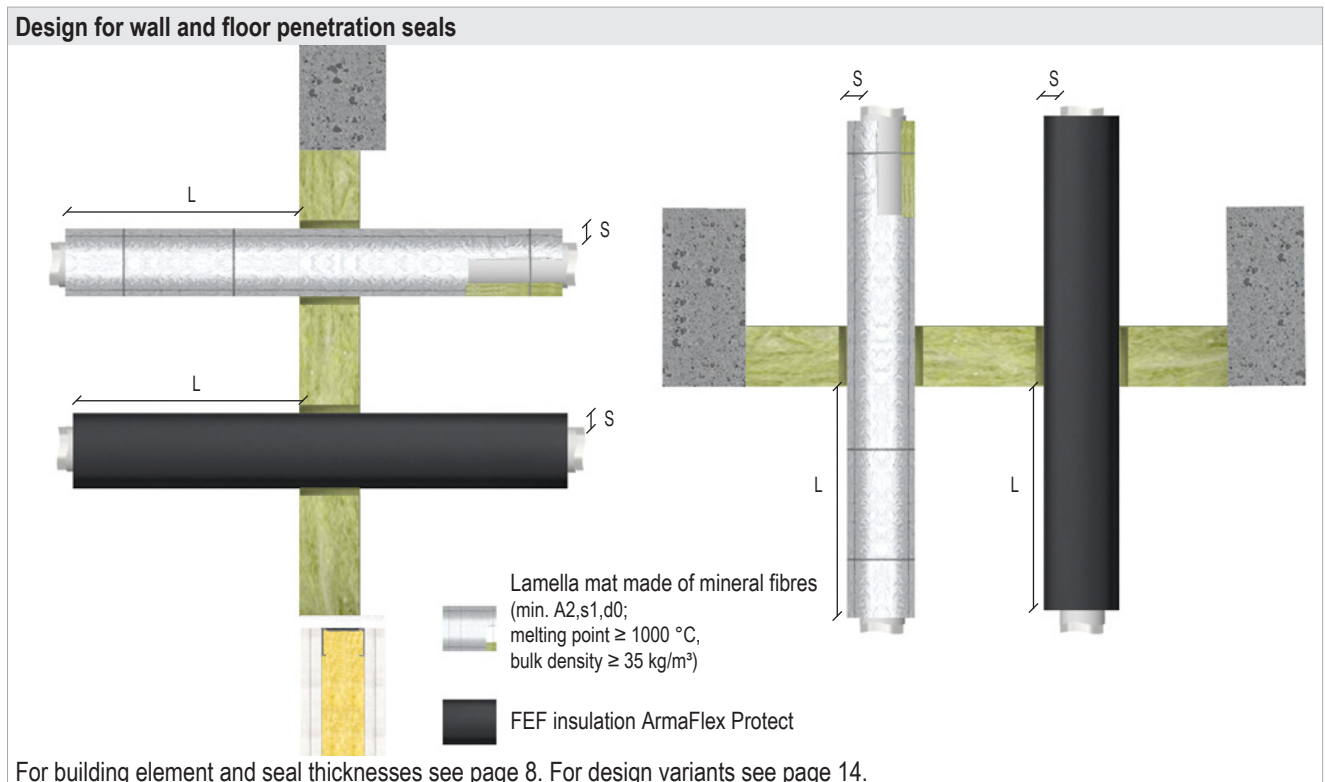

Wall				
Insulation with lamella mat				
Type of pipe	Pipe outer \varnothing [mm]	Insulation length L [mm]	Insulation thickness S [mm]	Fire resistance class
Henco	≤ 32.0	≥ 250 on each side	≥ 20.0	EI 30 U/C
	≤ 63.0		≥ 30.0	EI 30 U/C
Geberit Mepla	16.0		20.0–60.0	EI 90 U/C
	≤ 75.0		30.0–60.0	EI 60 / E 90 U/C
Geberit FlowFit	≤ 40.0		20.0–60.0	EI 90 U/C
	≤ 75.0		30.0–60.0	
KE KELIT KELOX KM 100 KE KELIT KELOX KM 110	≤ 32.0		20.0–80.0	EI 90 U/C
	≤ 75.0		30.0–80.0	
Insulation with FEF ArmaFlex Protect				
Henco	≤ 12	≥ 240 on each side	≥ 13	EI 30 U/C
	≤ 32		≥ 13	
	≤ 63		$\geq 26 (2 \times 13)$	

System Flammotect 1 × 60 mm

Floor				
Insulation with lamella mat				
Type of pipe	Pipe outer Ø [mm]	Insulation length L [mm]	Insulation thickness S [mm]	Fire resistance class
Henco	≤ 32.0	≥ 250 on each side	≥ 20.0	EI 90 U/C
	≤ 63.0		≥ 30.0	
Geberit Mepla*	16.0		20.0–60.0	EI 90 U/C
	≤ 75.0		30.0–60.0	
Geberit FlowFit*	≤ 20.0		20.0–60.0	EI 90 U/C
	≤ 75.0		30.0–60.0	
Uponor MLC pipe white S	≤ 110.0		≥ 30.0	EI 60 / E 90 U/C
Insulation with FEF ArmaFlex Protect				
Henco	≤ 12	≥ 240 on each side	≥ 13	EI 90 U/C
	≤ 32		≥ 13	
	≤ 63		≥ 26 (2 × 13)	
Uponor MLC pipe white S	≤ 110		≥ 26	EI 60 U/C

* as per KB 321100704-A Rev. 2

System Flammotect 1 × 60 mm

8.6.2 Design with FEF insulation and fire protection wrap KSL-W

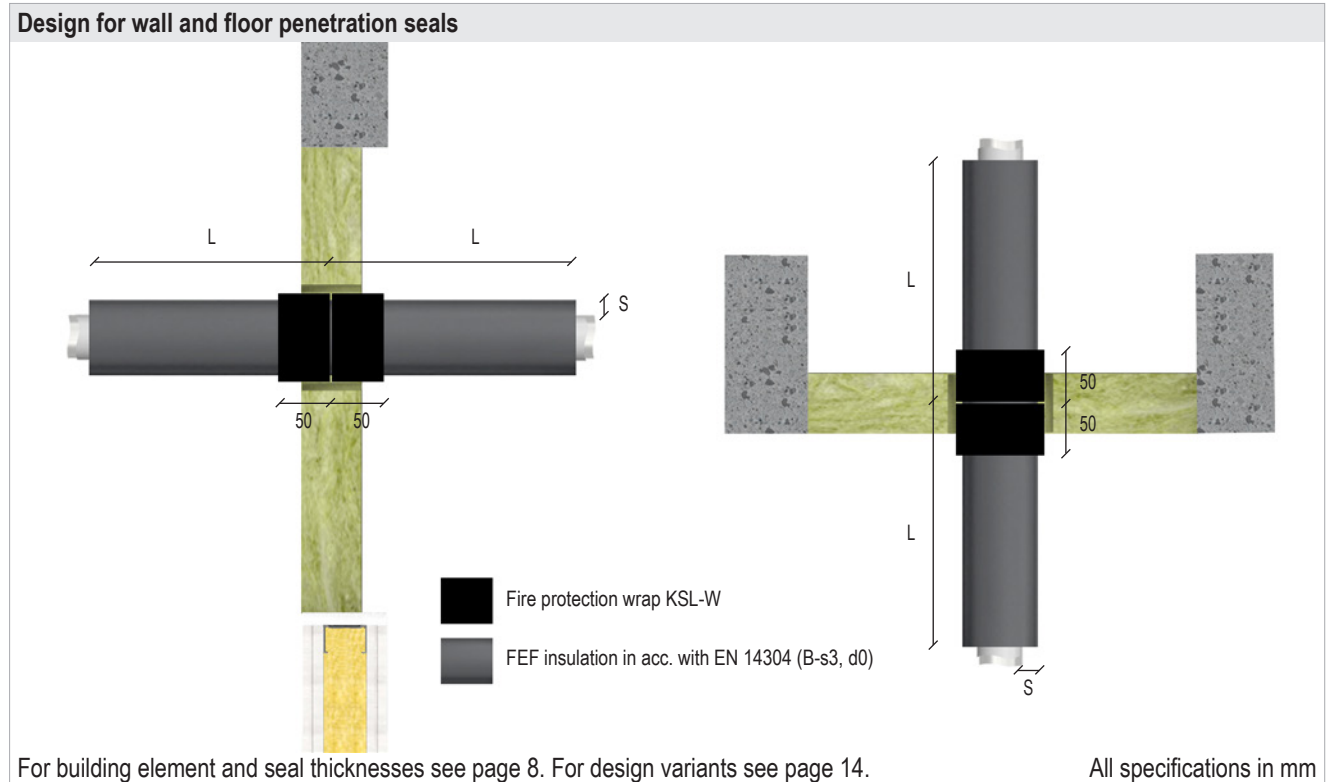

System Flammotect 1 × 60 mm

Wall						
Type of pipe	Outer Ø [mm]	FEF insulation in acc. with EN 14304 (B-s3,d0)		Fire protection wrap KSL-W		Fire resistance class*
		Insulation length L [mm]	Insulation thickness S [mm]	Number of wraps × width [mm]	Number of layers [n]	
Geberit Mepla	≤ 16.0	CS	8.0–35.0	2 × 50	1	EI 60 U/C / E 90 U/C
	≤ 32.0		16.0–35.0		1	
	≤ 75.0		14.0–39.0		2	
Geberit FlowFit	16.0	500	8.5–33.5	2 × 50	1	EI 60 U/C / E 90 U/C
	≤ 32.0		13.0–35.0		1	
	≤ 63.0	750	17.0–40.5		2	
	≤ 75.0		17.5–40.5		2	
KE KELIT KELOX KM 100, KE KELIT KELOX KM 110	16.0	220	8.0–35.0	2 × 50	1	EI 60 U/C / E 90 U/C
	≤ 32.0	250	9.0–35.0		1	
	≤ 75.0	500	13.0–40.5		2	

Floor						
Type of pipe	Outer Ø [mm]	FEF insulation in acc. with EN 14304 (B-s3,d0)		Fire protection wrap KSL-W		Fire resistance class*
		Insulation length L [mm]	Insulation thickness S [mm]	Number of wraps × width [mm]	Number of layers [n]	
Geberit Mepla	≤ 32.0	CS	8.0–35.0	2 × 50	1	EI 60 U/C / E 90 U/C
	≤ 63.0		14.0–40.5		2	
	≤ 75.0		17.0–40.5		2	
Geberit FlowFit	≤ 20.0	250	8.5–35.0	2 × 50	1	EI 60 U/C / E 90 U/C
	≤ 32.0		13.0–35.0		1	
	≤ 75.0	500	17.5–40.5		2	

* as per KB 321100704-A Rev. 2

System Flammotect 1 × 60 mm

8.6.3 Design with PEF insulation and fire protection wrap KSL-W

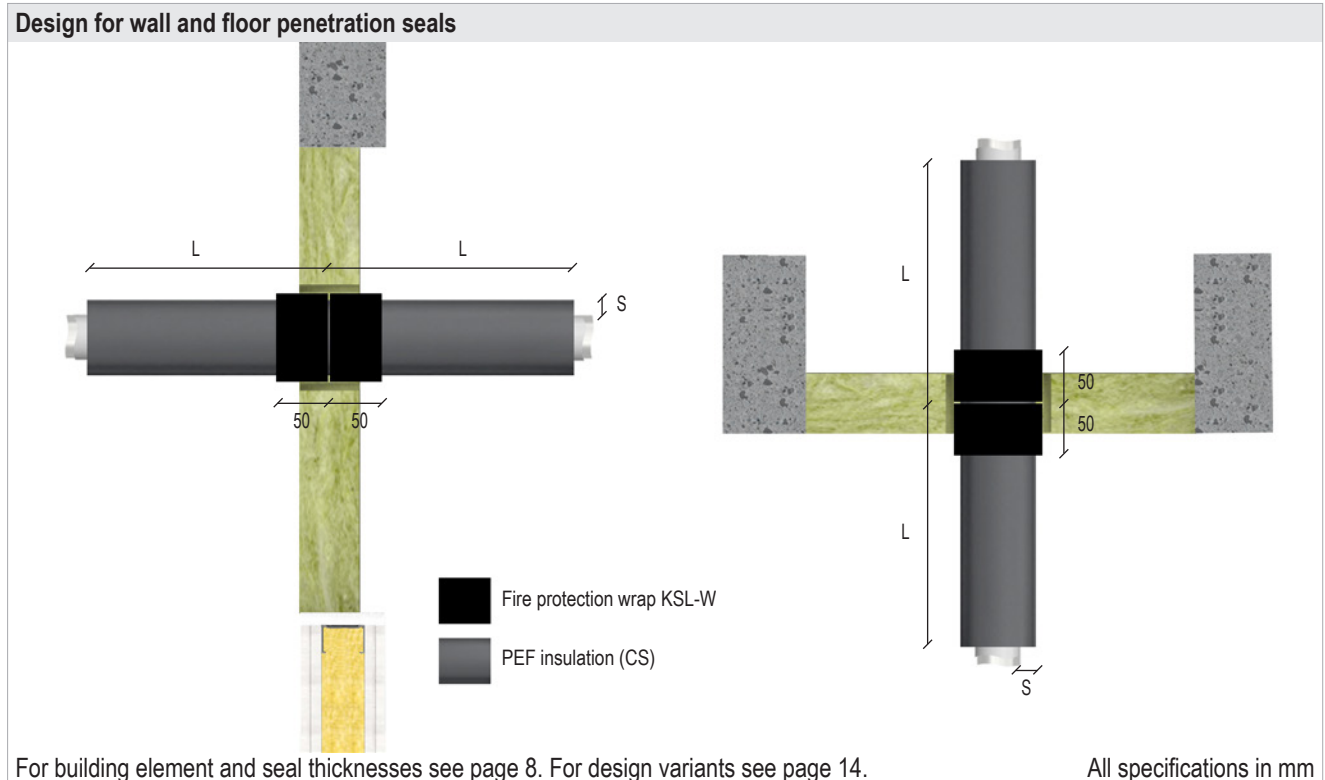

For building element and seal thicknesses see page 8. For design variants see page 14.

All specifications in mm

Wall						
Type of pipe	Outer Ø [mm]	PEF insulation		Fire protection wrap KSL-W		Fire resistance class*
		Insulation length L [mm]	Insulation thickness S [mm]	Number of wraps × width [mm]	Number of layers [n]	
Geberit Mepla	≤ 20.0	CS	6.0–26.0	2 × 50	1	EI 60 U/C / E 90 U/C
	≤ 26.0		6.0–13.0		1	EI 60 U/C / E 90 U/C
	≤ 26.0		6.0–26.0		1	EI 30 U/C / E 90 U/C
Geberit FlowFit	≤ 25.0	CS	6.0–26.0	2 × 50	1	EI 60 U/C / E 90 U/C
KE KELIT KELOX KM 100, KE KELIT KELOX KM 110	≤ 25.0	250	4.0–13.0	2 × 50	1	EI 60 U/C / E 90 U/C
	≤ 32.0	250	9.0–13.0		1	EI 60 U/C / E 90 U/C
	≤ 32.0	250	4.0–13.0		1	EI 30 U/C / E 90 U/C

Floor						
Type of pipe	Outer Ø [mm]	PEF insulation		Fire protection wrap KSL-W		Fire resistance class*
		Insulation length L [mm]	Insulation thickness S [mm]	Number of wraps × width [mm]	Number of layers [n]	
Geberit Mepla	≤ 26.0	CS	6.0–26.0	2 × 50	1	EI 90 U/C
Geberit FlowFit	≤ 25.0	CS	6.0–26.0	2 × 50	1	EI 90 U/C

* as per KB 321100704-A Rev. 2

System Flammotect 1 × 60 mm

8.6.4 Design with pipe shells

Design for wall penetration seals

Pipe shell made of mineral fibres (CS)
 min. A2-s1,d0,
 melting point ≥ 1000 °C,
 bulk density ≥ 80 kg/m³

For building element and seal thicknesses see page 8. For design variants see page 14. All specifications in mm

Multilayer pipes Geberit Mepla system pipe ML					
Pipe outer Ø [mm]	Pipe wall thickness [mm]	Pipe shell		Fire resistance class	
		Length [mm]	Insulation thickness [mm]	Wall	Floor
≤ 63	2.25–4.5	≥ 250 on both sides	20–30	EI 60 U/C / E 90 U/C	–

System Flammotect 1 × 60 mm

8.7 Non-combustible pipes

8.7.1 Design with section insulation made of lamella mat

Pipes may be arranged at all angles between 45° and 90°.

The lamella mat must be secured with winding wire against falling out.

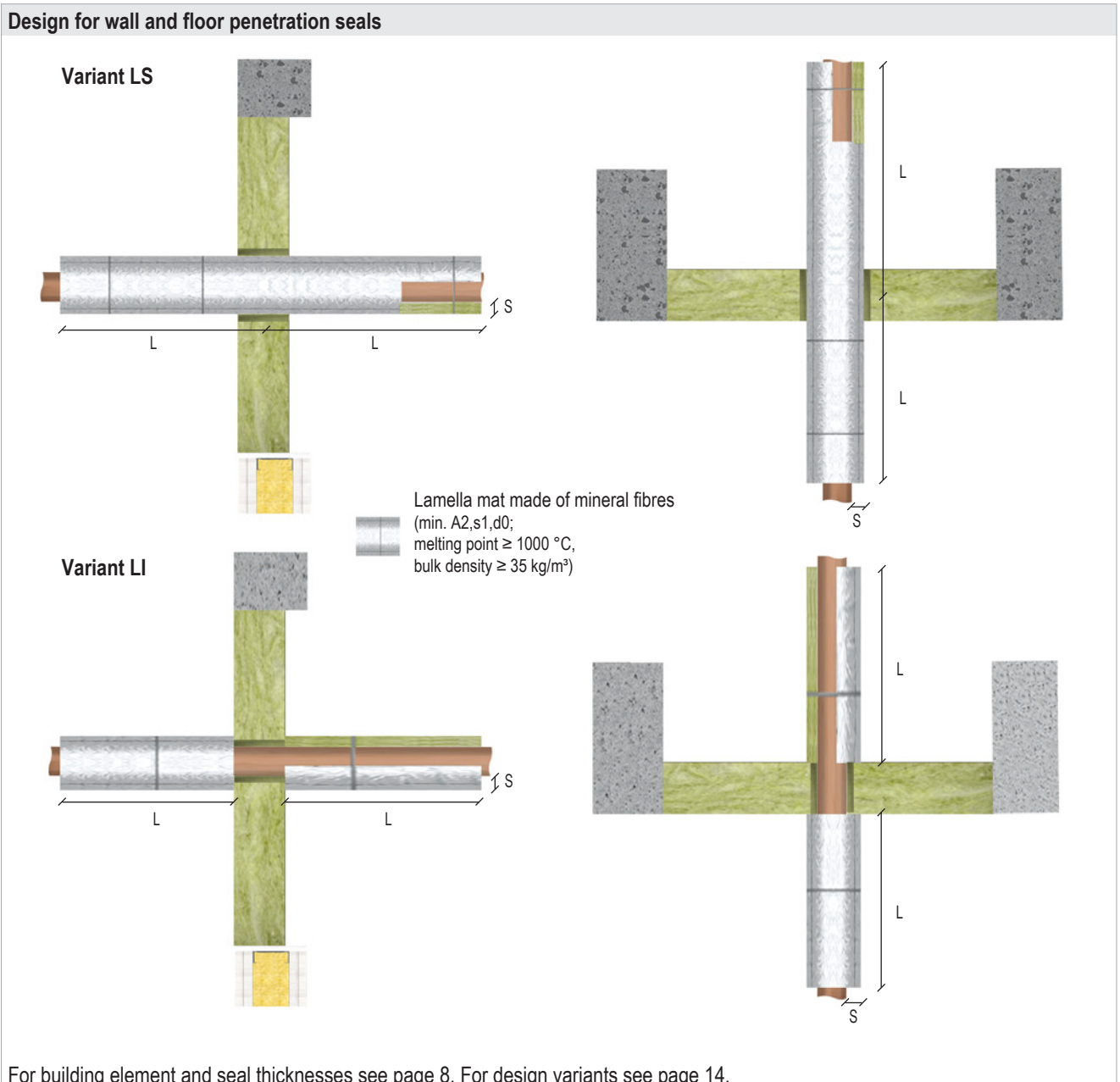

System Flammotect 1 × 60 mm

Wall					
Pipe material	Outer Ø [mm]	Pipe wall thickness [mm]	Section insulation made of lamella mat		Fire resistance class
			Insulation length L (LS/LI) [mm]	Insulation thickness S [mm]	
Copper, steel, stainless steel, cast iron	≤ 60.0	0.6–14.2	≥ 470.0 on both sides	30.0–100.0	EI 60 U/C / E 90 U/C
	≥ 60.0 – 88.9	0.6 / 2.0–14.2	≥ 720.0 on both sides		
Steel, stainless steel, cast iron	≥ 60.0 – < 114.3	0.6 / 2.8–14.2	≥ 470.0 on both sides		
	≥ 114.3 – < 219.1	2.8–14.2	≥ 470.0 on both sides		
		2.8 / 4.5–14.2	≥ 970.0 on both sides		
	219.1	4.5–14.2	≥ 970.0 on both sides		
Multiple penetration					
Up to three pipes made of copper, steel, stainless steel, cast iron	≤ 22.0	1.0–14.2	≥ 470.0 on both sides	30.0	EI 60 U/C / E 90 U/C

System Flammotect 1 × 60 mm

Floor					
Pipe material	Outer Ø [mm]	Pipe wall thickness [mm]	Section insulation made of lamella mat		Fire resistance class
			Insulation length L (LS/LI) [mm]	Insulation thickness S [mm]	
90 minutes					
Copper, steel, stainless steel, cast iron	≤ 42.0	1.0–14.2	≥ 470.0 on both sides	30.0	EI 90 U/C
	≥ 42.0 – ≤ 88.9	1.0 / 2.0–14.2	≥ 970.0 on both sides		
Steel, stainless steel, cast iron	≤ 63.5	0.8 / 2.3–14.2	≥ 220.0 on both sides	30.0–100.0	
	≥ 63.5 – ≤ 114.3	2.3 / 3.2–14.2	≥ 470.0 on both sides		
	≥ 114.3 – ≤ 159.0	2.3 / 3.6–14.2	≥ 970.0 on both sides		
60 minutes					
Copper, steel, stainless steel, cast iron	≤ 15.0	0.8–14.2	≥ 220.0 on both sides	30.0–100.0	EI 60 U/C
	≥ 15.0 – ≤ 42.0	1.0–14.2	≥ 470.0 on both sides		
	≥ 42.0 – ≤ 88.9	1.0 / 2.0–14.2	≥ 970.0 on both sides		
Steel, stainless steel, cast iron	≥ 159.0 – ≤ 219.1	3.6 / 4.0–14.2	≥ 970.0 on both sides		
Multiple penetration					
Up to three pipes made of copper, steel, stainless steel, cast iron	≤ 22.0	1.0–14.2	≥ 425.0 on both sides	30.0	EI 45 U/C / E 90 U/C

System Flammotect 1 × 60 mm

8.7.2 Design with FEF insulation and fire protection wrap NBR-plus

The fire protection wrap NBR-plus is coated on one side and equipped with a protective film. The film must be removed before applying the wrap with the coated side facing inwards.

For easier installation the wrap can be secured against falling out with duct tape or winding wire.

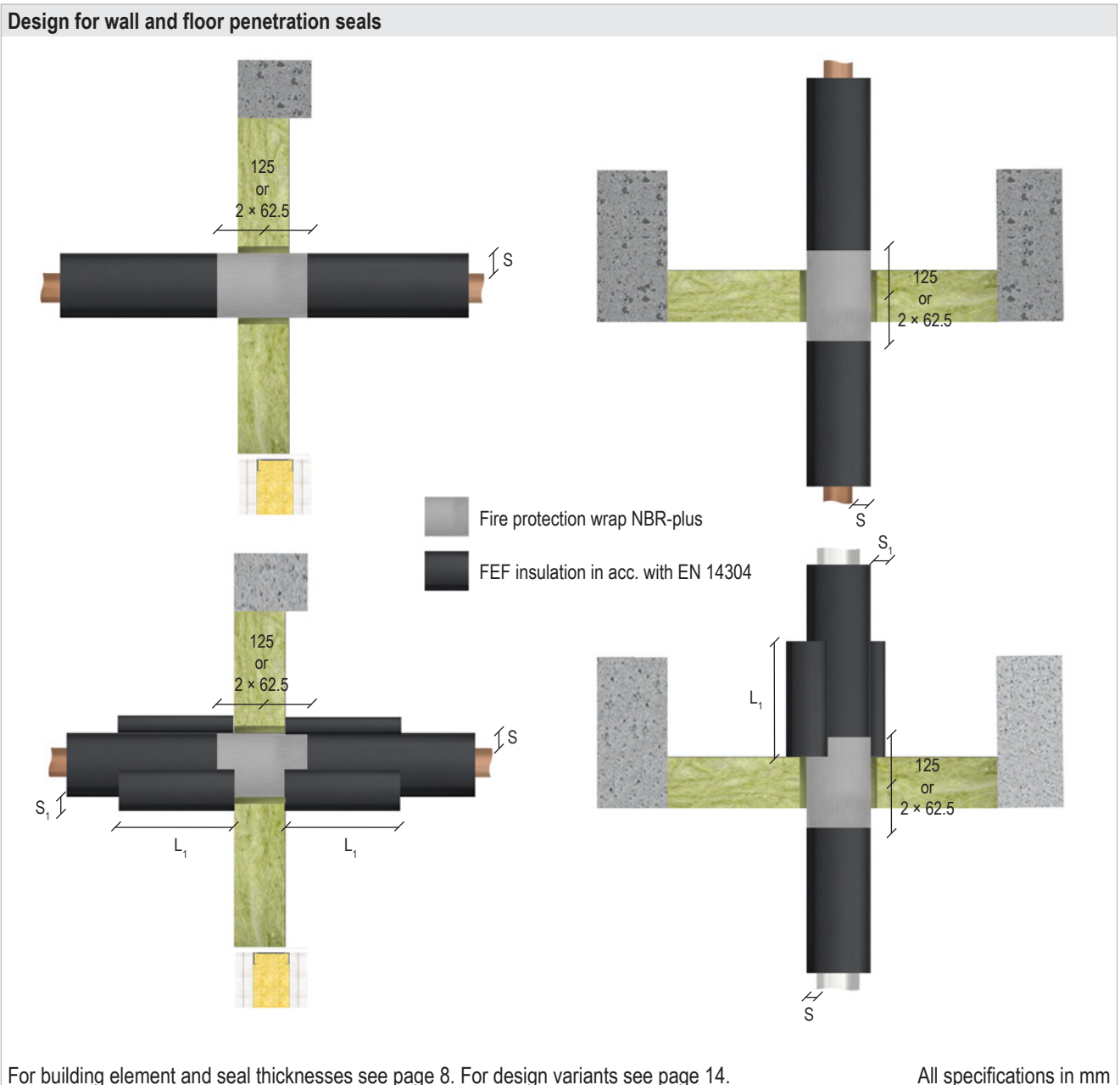

System Flammotect 1 × 60 mm

Wall													
Pipe material	Outer Ø [mm]	Pipe wall thickness [mm]	Section insulation		Protective insulation		NBR-plus		Fire resistance class				
			Length	Thickness S [mm]	Length L ₁ [mm]	Thickness S ₁ [mm]	Number of wraps × width [mm]	Number of layers [n]					
60 minutes													
Copper, steel, stainless steel, cast iron	≤ 15.0	0.6–14.2	CS	10.0–38.0	–	–	2 × 62.5 or 1 × 125	2	EI 60 U/C				
	≤ 42.0			12.0–38.0	–	–		2					
	≤ 60.0			19.0–38.0	–	–		2					
	≤ 88.9			22.5–38.0	–	–		2					
Steel, stainless steel, cast iron	≤ 88.9					15.5–38.0		–		–		2	
	≤ 114.3					15.0–38.0		–		–		2	
	≤ 159.0					25.0–38.0		250.0		19.0		2	
	≤ 219.1					25.0–38.0		250.0		38.0		2	
30 minutes													
Copper, steel, stainless steel, cast iron	≤ 42.0	0.6–14.2	CS	10.0–38.0	–	–	2 × 62.5 or 1 × 125	2	EI 30 U/C				
	≤ 88.9			18.0–38.0	–	–		2					

System Flammotect 1 × 60 mm

Floor										
Pipe material	Outer Ø [mm]	Pipe wall thickness [mm]	Section insulation		Protective insulation		NBR-plus		Fire resistance class	
			Length	Thickness S [mm]	Length L ₁ [mm]	Thickness S ₁ [mm]	Number of wraps × width [mm]	Number of layers [n]		
60 minutes										
Copper, steel, stainless steel, cast iron	≤ 15.0	0.6–14.2	CS	10.0–38.0	–	–	2 × 62.5 or 1 × 125	2	EI 60 U/C	
	≤ 42.0			12.0–38.0	–	–		2		
	> 42.0 – ≤ 88.9			19.0	–	–		2		
	≤ 88.9			22.5–38.0	–	–		2		
Steel, stainless steel, cast iron	≤ 15.0	3.2–14.2		10.0–38.0	–	–		2 × 62.5 or 1 × 125		2
	≤ 42.0			15.0–38.0	–	–				2
	≤ 88.9			18.5–38.0	–	–				2
	≤ 114.3	18.5–38.0		–	–	2				
	≤ 159.0	4.0–14.2		25.0–38.0	250.0	19.0				2
	≤ 219.1	4.5–14.2		25.0–38.0	250.0	38.0				2
30 minutes										
Copper, steel, stainless steel, cast iron	≤ 42.0	0.6–14.2	CS	10.0–38.0	–	–	2 × 62.5 or 1 × 125	2	EI 30 U/C	
	≤ 88.9			19.0–38.0	–	–		2		

System Flammotect 1 × 60 mm

8.7.3 Design with FEF insulation ArmaFlex Protect

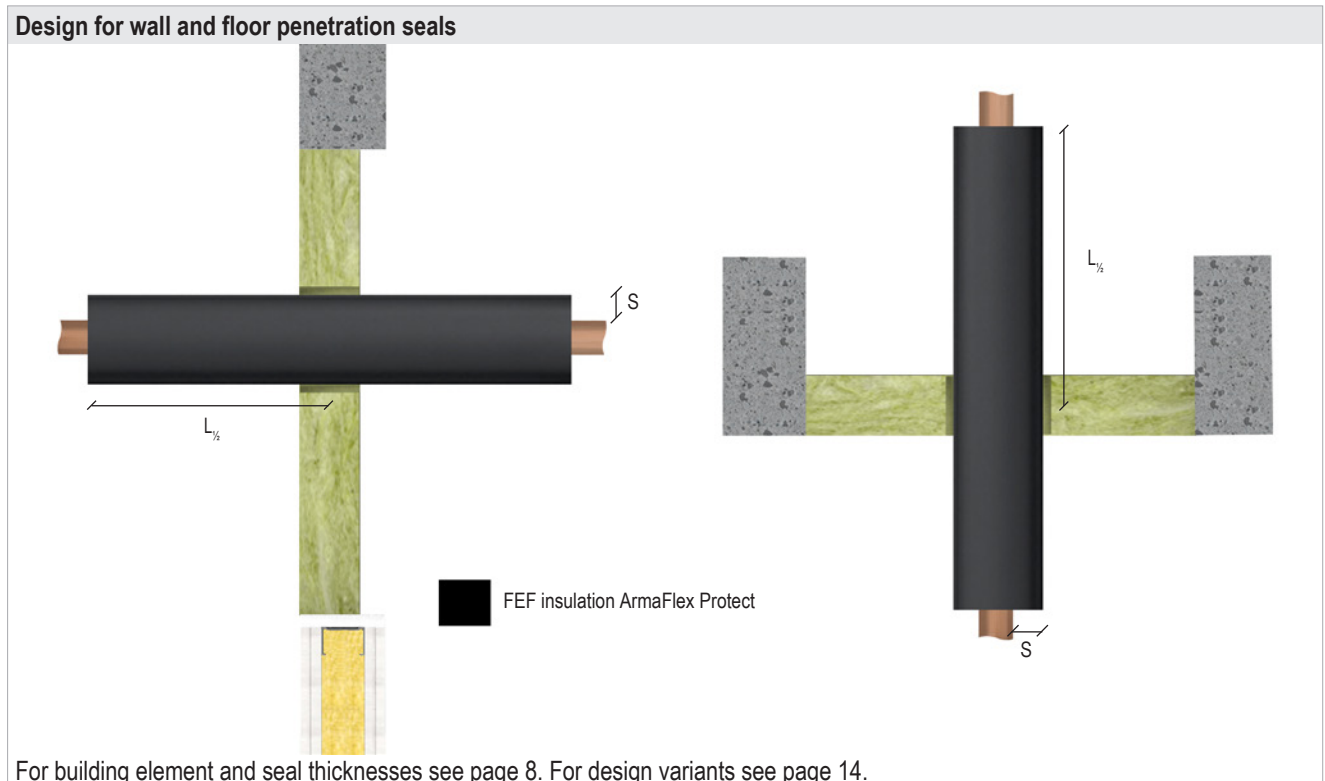

Non-combustible pipes made of copper, steel, stainless steel or cast iron					
Pipe outer Ø [mm]	Pipe wall thickness [mm]	FEF insulation ArmaFlex Protect		Fire resistance class	
		Length $L_{1/2}$ [mm]	Thickness S [mm]	Wall	Floor
≤ 88.9	≥ 0.8	≥ 500	25–51	EI 60 / E 90 C/U	EI 60 / E 90 C/U
Non-combustible pipes made of steel, stainless steel or cast iron					
≤ 170	≥ 3.0	≥ 1000	26–52	EI 90 C/U	EI 60 / E 90 C/U

System Flammotect 1 × 60 mm

8.7.4 Design with PIR insulation

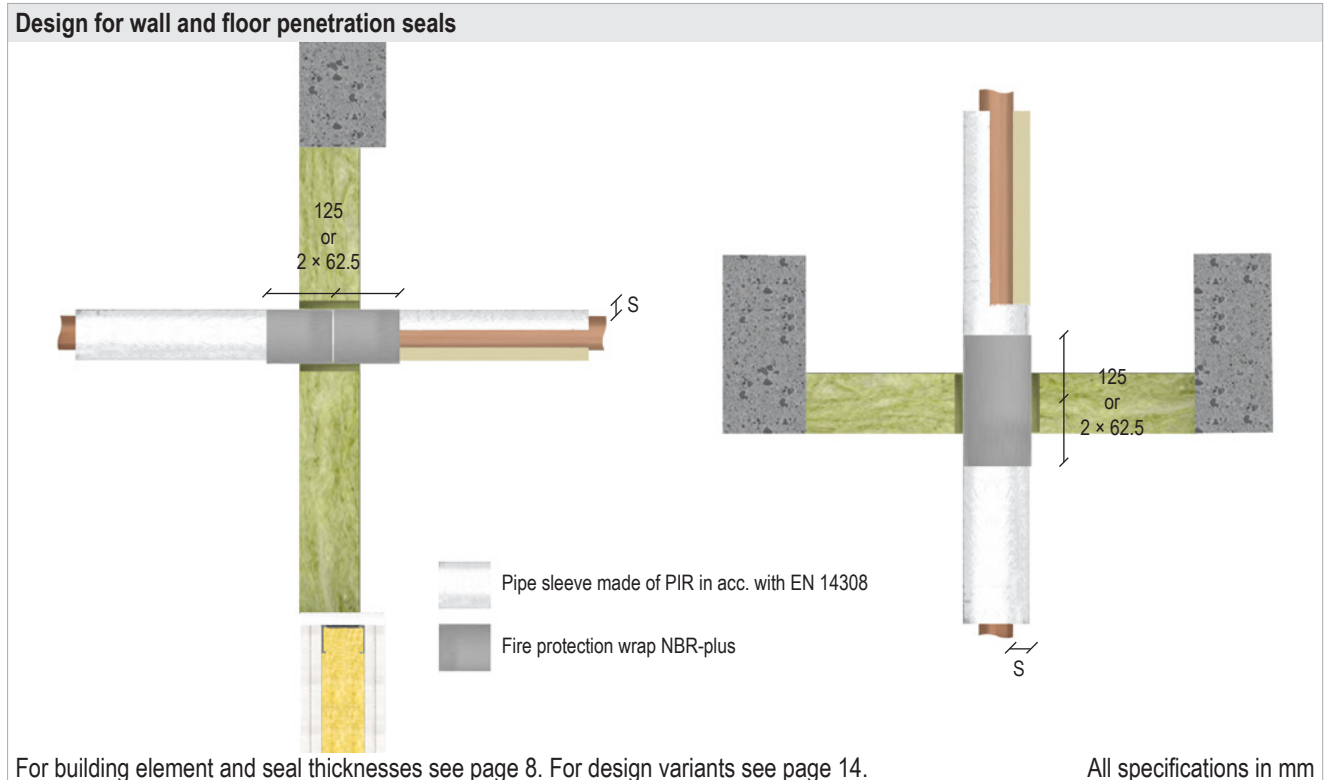

For building element and seal thicknesses see page 8. For design variants see page 14.

All specifications in mm

Wall					
Non-combustible pipes made of copper, steel, stainless steel or cast iron					
Pipe outer Ø [mm]	Pipe wall thickness [mm]	PIR insulation	Fire protection wrap NBR-plus		Fire resistance class
		Insulation thickness S [mm]	Number of wraps × width [mm]	Number of layers [n]	
≤ 28.0	≥ 1.0 – ≤ 14.2	30	2 × 62.5 or 1 × 125	2	EI 60 C/U
		50		3	
≤ 88.9	≥ 1.5 – ≤ 14.2	80		4	
Non-combustible pipes made of steel, stainless steel or cast iron					
≤ 88.9	≥ 2.9 – ≤ 14.2	100	2 × 62.5 or 1 × 125	4	EI 60 C/U
≤ 133.0	≥ 3.6 – ≤ 14.2			4	
≤ 219.1	≥ 4.5 – ≤ 14.2	60		3	
		100		4	

System Flammotect 1 × 60 mm

Floor					
Non-combustible pipes made of copper, steel, stainless steel or cast iron					
Pipe outer Ø [mm]	Pipe wall thickness [mm]	PIR insulation	Fire protection wrap NBR-plus		Fire resistance class
		Insulation thickness S [mm]	Number of wraps × width [mm]	Number of layers [n]	
≤ 28.0	≥ 1.0 – ≤ 14.2	20	2 × 62.5 or 1 × 125	2	EI 60 C/U
		50		3	EI 90 C/U
≤ 42.0	≥ 1.2 – ≤ 14.2	30		2	EI 60 C/U
		60		3	
≤ 54.0	≥ 1.5 – ≤ 14.2	30		2	
		80		4	
≤ 88.9	≥ 2.0 – ≤ 14.2	40		2	
		50		3	
		100		4	
Non-combustible pipes made of steel, stainless steel or cast iron					
≤ 88.9	≥ 2.9 – ≤ 14.2	30	2 × 62.5 or 1 × 125	2	EI 60 C/U
		100		4	
≤ 133.0	≥ 3.6 – ≤ 14.2	40		2	
		100		4	
≤ 219.1	≥ 4.5 – ≤ 14.2	40		2	
		60		3	
		100	4		

System Flammotect 1 × 60 mm

8.8 HVAC split line combinations

The fire protection wrap NBR-plus is coated on one side and equipped with a protective film. The film must be removed before applying the wrap with the coated side facing inwards.

For easier installation the wrap can be secured against falling out with duct tape or winding wire.

Design for wall and floor penetration seals with fire protection wrap NBR-plus

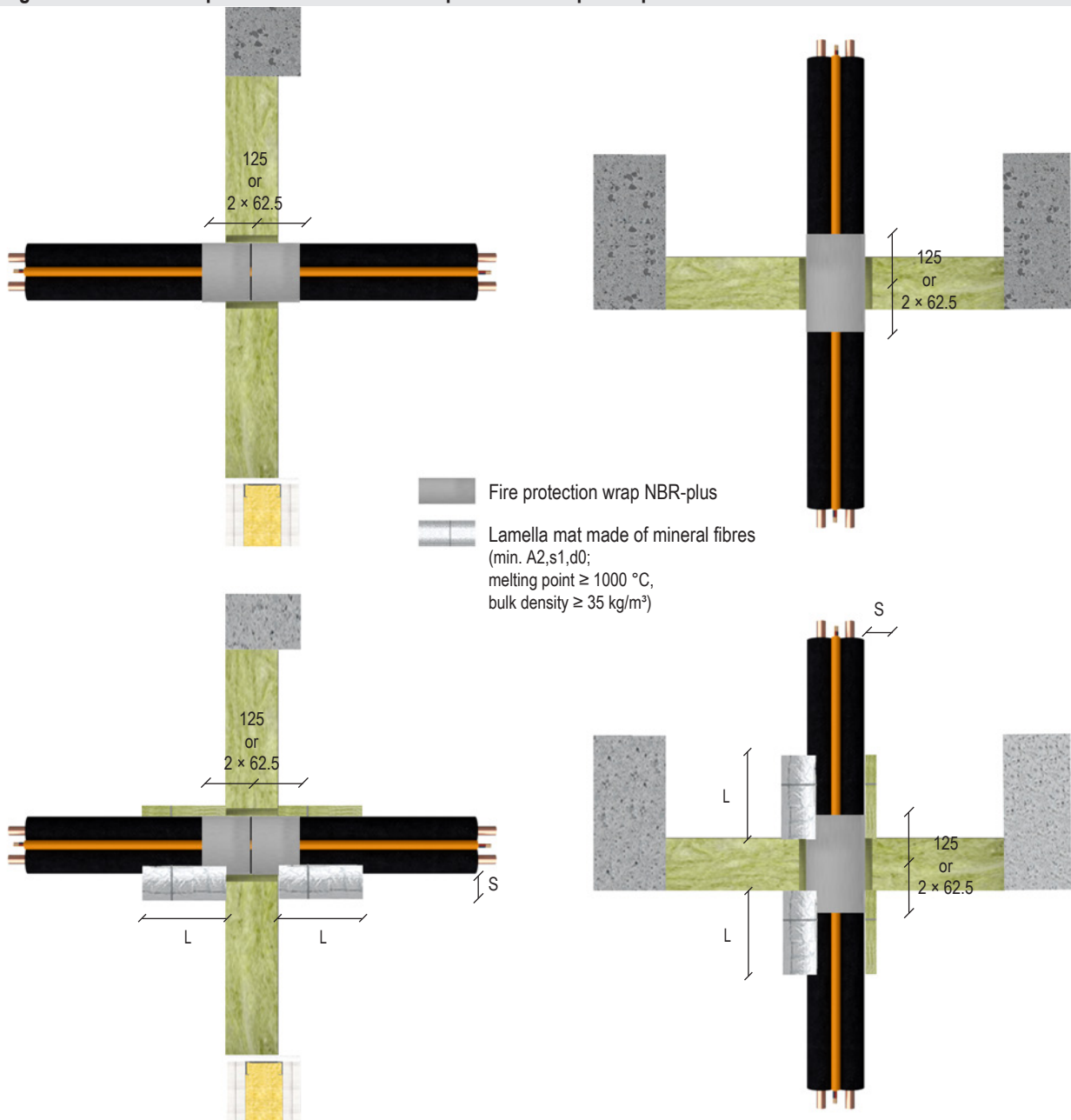

For building element and seal thicknesses see page 8. For design variants see page 14.

All specifications in mm

System Flammotect 1 × 60 mm

Configuration	Fire protection wrap NBR-plus		Protective insulation made of lamella mat		Fire resistance class	
	Number of wraps × width [mm]	Number of layers [n]	Length L [mm]	Thickness S [mm]	Wall	Floor
Copper pipe ≤ 2 × Ø 18 mm, + 9 mm PE foam, + 1 pipe PVC-U Ø ≤ 25.0 × 1.5 mm, + ≤ 3 × cables Ø ≤ 14.0 mm	2 × 62.5 or 1 × 125	2	–	–	EI 60	EI 60
Copper pipe 2 × Ø 22 mm + 9 mm PE foam, + 1 pipe PVC-U Ø ≤ 25.0 + 2 × cables Ø ≤ 21.0 mm			≥ 250	≥ 30	EI 30	EI 90

System Flammotect 1 × 60 mm

8.9 Double solar pipes NanoSun²

The fire protection wrap NBR-plus is coated on one side and equipped with a protective film. The film must be removed before applying the wrap with the coated side facing inwards.

For easier installation the wrap can be secured against falling out with duct tape or winding wire.

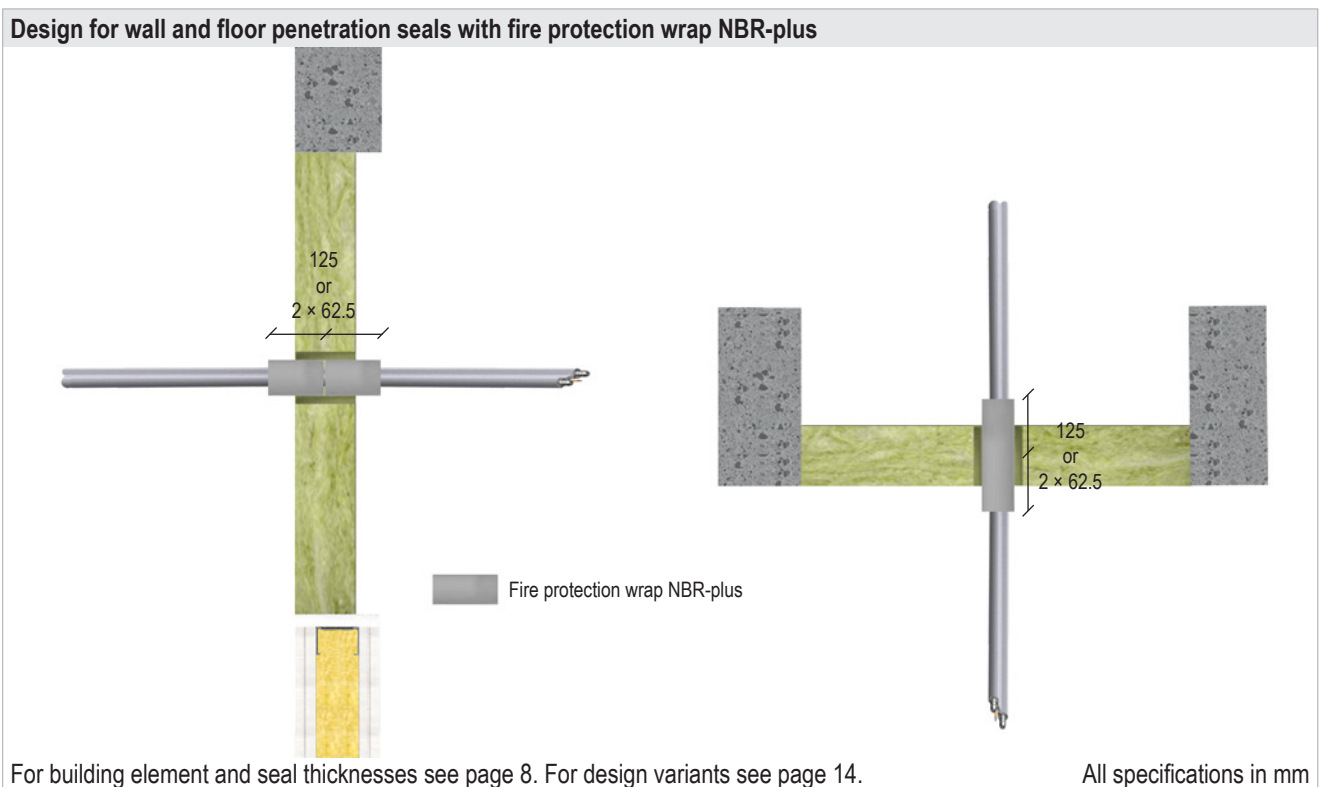

Nominal width	Fire protection wrap NBR-plus			Fire resistance class	
	Number of wraps × width [mm]	Number of layers [n]	Overlap [mm]	Wall	Floor
DN 16	2 × 62.5 or 1 × 125	1	25	EI 90	EI 60
DN 40				EI 30 / E 90 U/U	EI 60

System Flammotect 1 × 60 mm

9. Installation steps

1. Clean the aperture edge. (The aperture edge must be cladded.) When installing in sandwich panel walls, attach L profiles with the dimensions 30 × 30 × 2 mm alongside the aperture edge on both sides of the seal.

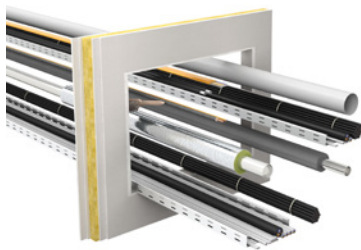

2. Mask the opening with crepe tape on all sides, keeping 20 mm distance to the edge. Coat the cables with FLAMMOTECT-A; alternatively apply fire protection wrap.

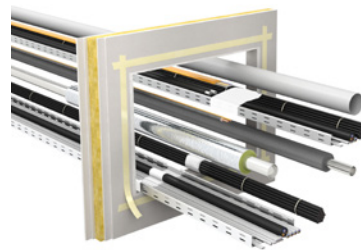

3. Apply fire protection wraps to services, if necessary.

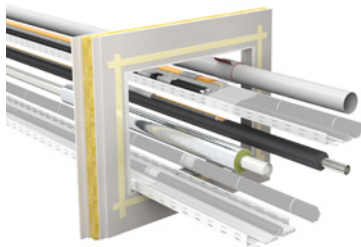

4. Cut mineral fibre boards to size (make cut-outs for the installations).

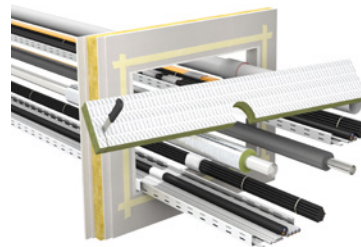

5. Coat the edges of the mineral fibre boards with FLAMMOTECT-A and firmly place boards in position.

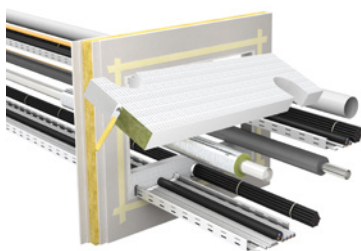

6. Seal the remaining opening/joints with mineral fibre or fill them with FLAMMOTECT-A.

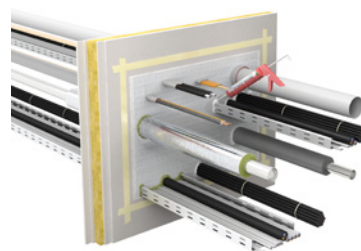

System Flammotect 1 × 60 mm

7. Final coating with FLAMMOTECT-A. Install pipe collars if necessary.

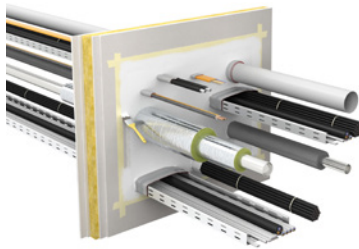

8. If required, label the penetration seal. Fill out the label neatly and attach it firmly next to / above (not on) the penetration seal.

